

# The Department of Geodesy and Geoinformatics

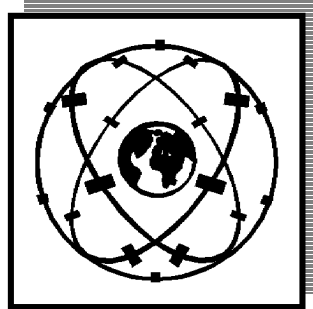
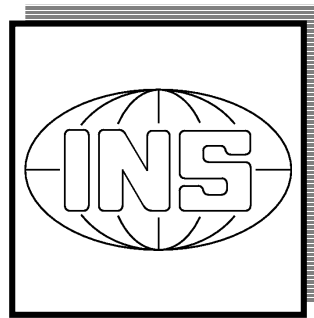

Stuttgart University  
**2001**

**editing and layout:**

volker walter, friedhelm krumm, ulrich hangleiter, wolfgang schöller

---

## Preface

It is with great pleasure to report the highlights 2001 of The Department of Geodesy and Geoinformatics (DoGG), Stuttgart University. This annual report, introduced in 1993, serves in the meantime as a helpful compendium for all our friends around the world. As before, the Stuttgart School will help to shape the future of satellite and mathematical geodesy, navigation, land surveying and engineering surveys, telematics, photogrammetry, remote sensing, optical inspection, geographic information systems and Location Based Services.

To be prepared for the future, the Department had to decide a new faculty link during the restructuring negotiations of the university. Although we were always welcome within the Faculty of Civil Engineering and Surveying for the last 20 years, attractive offers from two other Faculties, Computer Science and Aerospace Engineering, opened up new horizons for the future. After balancing both offers we finally decided to change to the Aerospace Engineering Faculty, which is now called „Faculty of Aerospace Engineering and Geodesy“. We hope, that this strategic decision will better image the more technological content of our profile.

The number of incoming students has positively changed. Obviously, the Department attracts many foreign students, especially from China and the Near East. The integration of these students is a human task and important for a global society, thus we will altogether make helpful contributions, the German students and the DoGG staff members as well. We hope, to offer very soon the Bachelor/Master system to have a well-defined interface for foreign students, parallel to the German Diploma Engineer curriculum.

As before, this report is on the WEB to allow for colored figures and further services: downloads of papers, videos, lecture notes, etc. Please visit our website:

<http://www.ifp.uni-stuttgart.de/jahresberichte/jahresbericht.html>

Dieter Fritsch  
Alfred Kleusberg

Erik W. Grafarend  
Wolfgang Möhlenbrink

Wolfgang Keller





## Institute for Applications of Geodesy to Engineering

Geschwister-Scholl-Str. 24/D, D-70174 Stuttgart,  
Tel.: +49 711 121 4041, Fax: +49 711 121 4044  
e-mail: Sekretariat@iagb.uni-stuttgart.de or  
firstname.secondname@iagb.uni-stuttgart.de  
url: <http://www.uni-stuttgart.de/iagb/iagb.html>

### Head of Institute

Prof. Dr.-Ing. Wolfgang Möhlenbrink  
Dipl.-Ing. Ulrich Hangleiter, Akad. Direktor

### Secretary

Christel Schüler

### Emeritus

Prof. Dr.-Ing. Dr.sc.techn.h.c. Dr.h.c. Klaus Linkwitz

### Scientific Staff

Dipl.-Ing. Roland Bettermann	Traffic Information
Dr.-Ing. Renate Czommer	Map matching
Dipl.-Ing. Matthias Dünisch	Geodetic Measurements
Dipl.-Ing. Andreas Gläser	Integrated Sensors
Dipl.-Ing. Andreas Eichhorn	Deformation Analysis
Dipl.-Geogr. Thilo Kaufmann (since 15.7.01)	Digital Maps
Dr.-Ing. Heiner Kuhlmann	Surveying Engineering
Dipl.-Ing. Katrin Ramm (since 1.5.01)	Vehicle Positioning
Dipl.-Ing. Ralph Schollmeyer (since 15.11.01)	Vehicle Positioning
Dipl.-Ing. Martin Stark	Information Chains
Dipl.-Ing. Thomas Wiltschko	Information Quality

## Technical Stuff

Niklaus Enz  
Martin Knihs  
Lars Plate (since 1. 10. 01)  
Doris Reichert

## General View

The institute's main tasks in education and research traditionally reflect on surveying, geodetic measurement techniques, engineering geodesy, data processing and traffic information technologies. The daily work is characterised by intensive correlation and co-operation with other engineering disciplines, especially with civil engineering, traffic engineering and construction management. Co-operations exist with other university institutes as well as with the construction and automobile industry and various traffic services.

The education of geodesists is characterised by the perfection of existing lectures and practices. The institute is not only responsible for different courses within the curricula of Geodesy and Geo-related Computer Science but also for the education in surveying of architects and civil engineers. A special lecture in English is held within the master course Infrastructure Planning. Additionally, first steps towards a virtual learning environment are realised. The current research in the fields of geodetic measurement techniques and traffic information techniques is reflected in most lectures. This is also represented in various case studies and diploma theses, often realised in co-operation with industry and public administration.

The institute's current research and development work focuses on the following:

- ▷ geodetic measurement techniques
- ▷ traffic information techniques
- ▷ positioning and guidance in vehicle navigation
- ▷ formfinding of lightweight structures.

In the main field of traffic information techniques the institute is engaged in various scientific projects with the aim to guarantee and improve mobility. The fields of geodetic measurement techniques and vehicle navigation get their impulses from industrial projects.

## Research Work

The research work can be summarized by the main topic 'Positioning and controlling moving objects in the digitally described 3D-space'. This research work comprises the following activities:

## Geodetic Measurement Techniques

This working area comprises design, development and application of multi-sensor-measurement and data processing of static and dynamic information in civil engineering and surveying. The main interest is laid on the integrated application of different sensors for the determination of building deformations and vehicle navigation.

### Sensor Integration and Position Estimation for Vehicle Navigation

Within an industry project an algorithm was developed for map-independent navigation of vehicles. This algorithm disposes of the position in realtime by means of on-board multi sensor system. The sensor system includes absolute GPS, a gyro determining the yaw rate of the vehicle and a wheel pulse counter, thus deriving distance and orientation by the difference between left and right wheel. During the test differential GPS was used as reference. A schematic measurement arrangement is shown in figure 1.

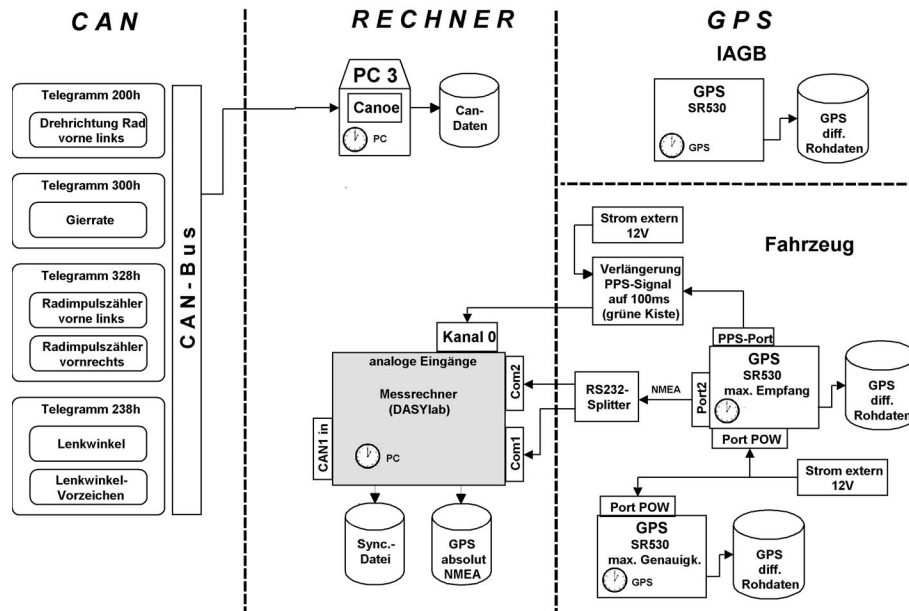

Fig. 1: Data Acquisition

After a quality test of the sensors showing the stochastic observation model, a Kalman-filter was formulated with vehicle position, vehicle speed and orientation as estimated parameters. Thus failures and mistakes of the GPS-observations can be compensated.

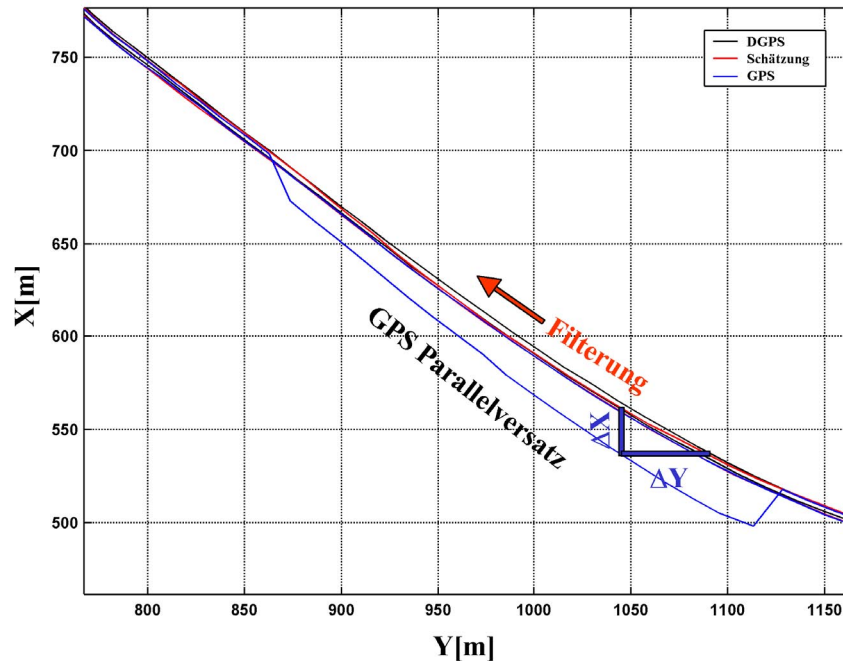

Fig. 2: Filtering of GPS-error: parallel offset from multipath

Figure 2 shows an example for standard deviation of  $\sigma_x = \sigma_y = 2$  m of the positions estimated.

### Deformation Measurements of a Bridge

For proving the stability of highway bridges, deformations are usually determined by levelling which is an extensive measurement procedure. Within a project in co-operation with the Landesamt für Straßenwesen, Baden-Württemberg alternative measurement and evaluation procedures have been tested. The measuring procedure was effected by means of two different methods: with reflectorless tacheometry (scanning of the building, see figure 3) and with GPS-RTK measurements. In both procedures the deformations are not represented by movements of individual points but by a comparison of forms, as shown in figure 4.

The tests showed that the procedure of GPS-RTK did not meet the accuracy requirements as deformations of 1 cm could not reproducibly be identified (empiric standard deviation  $s = 9$  mm). Reflectorless tacheometry, however, met these requirements whereby accuracy depends on the angle of the line of sight meeting the concrete surface. Similar instrument stations showed an empiric standard deviation of  $s = 0,6 \dots 1,6$  mm by means of differences. Compared to levelling a considerably shorter measuring time could be achieved.



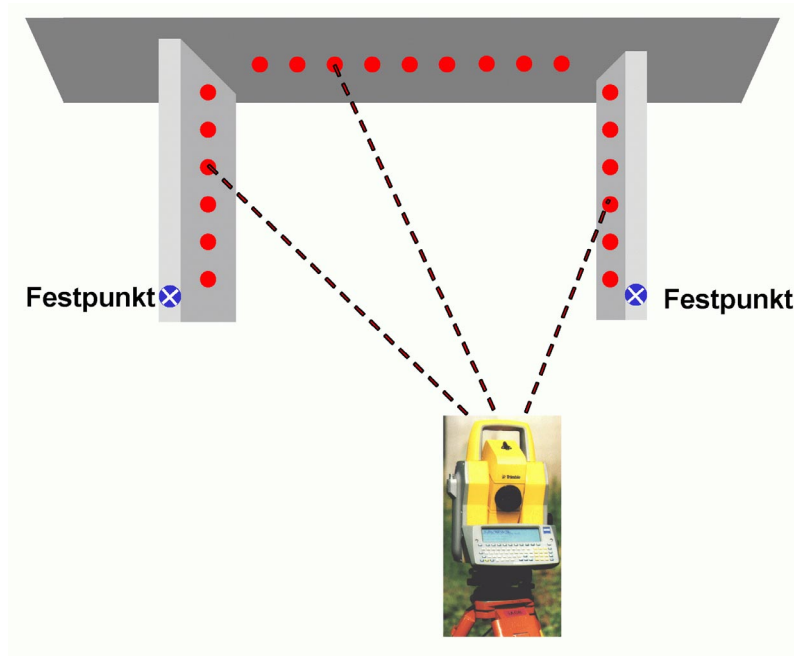

Fig. 3: Scanning by reflectorless tacheometry

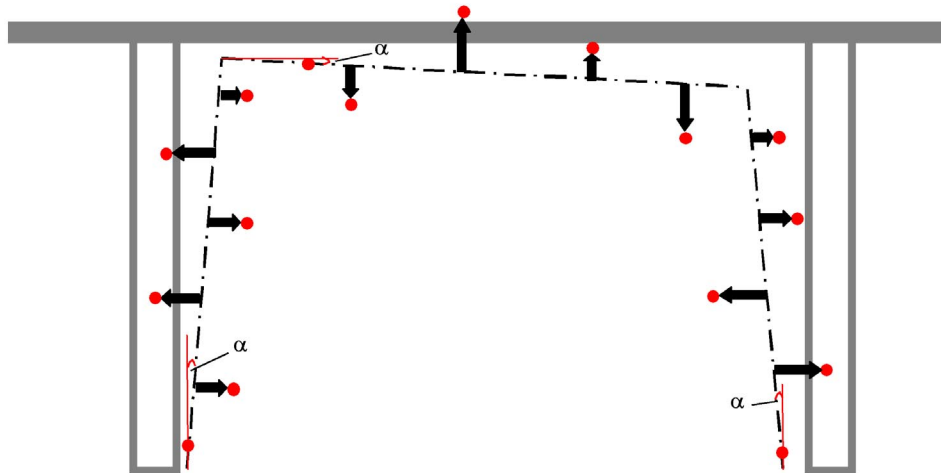

Fig. 4: Determination of shape with straight regression lines and deviations of single points

## Methodical Development of Deformation Models

The description of the transfer function of an object relating to its external influences (i.e. temperature) is a fundamental task within the deformation analysis. By solving this problem, it is possible to predict relevant object reactions considering deterministic correcting variables. Thus critical system states can be simulated.

In case of a quantifiable physical structure, the time domain transfer function can be formulated by differential equations („White-Box-Model“). With this dynamic modelling method, the system's capacity to store and deliver energy with a time delay can be taken into consideration. Consequently, the system's behaviour under dynamic loads, respectively the transition between static load states can be described.

In this context, second order differential equations are combined with observations to a dynamic Kalman filter. The material parameters included in the system equations, defined as priori unknown, can be estimated by the adaptive extension of the state vector with a physical partition. Therefore, the adaptation of the system model to the observations can be reached by parametrical identification. A practical realisation is effected by the identification of oscillating systems. It has been shown that convergent solutions are possible, whereby only few oscillations of the system are required for the identification phase.

## Specification of computers with graphic interface for applications of land surveying

By using modern information and communication technology systems as well as data processing the working procedures in surveying are increasingly automated from data acquisition to data processing and presentation. A possible scenario is shown in figure 5.

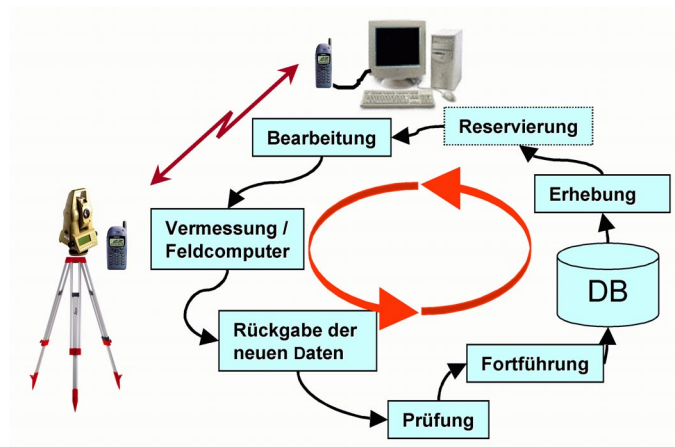

Fig. 5: Data acquisition and processing

The working process in surveying generally needs graphics on site (see figure 6). This practically means manual sketches completed by relevant information and general object-describing attributes. Sketches are necessary for object documentation and are an important part of the surveying documents. This mode of operation requires manual rework in office before the digital basis data can be continued.

Using graphical PC (Pen PC) with respective graphic editorial possibilities the reliability and thus the quality of measurement results can be improved. As the official surveying authorities of Baden-Württemberg intend to use Pen PC's for field surveying purposes test series for the use of those systems were performed in co-operation of the Landesvermessungsamt and the institute. First of all, the requirements for such Pen PC'S were determined by a functional analysis. The market situations was tested referring to the results. Practical tests with the most suitable products followed with a final recommendation showing that suitable products exist. Many of the specified requirements were proved to be unproblematical. Crucial criteria are portability and legibility of the display, outdoor-use, however, the major impact lies on the display legibility. Up to now there exists no display in DIN-A4-size being legible under direct sun.

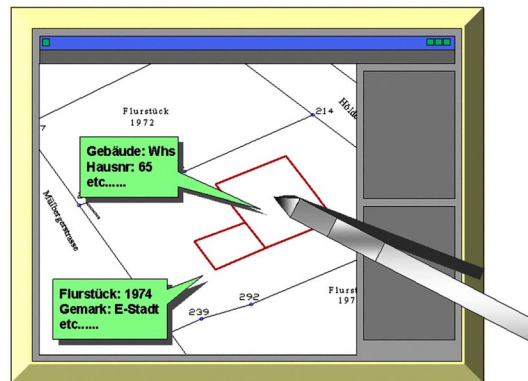

Fig. 6: Graphical representation with attributes

## Traffic Information Technology

Within the area of traffic telematics the institute is involved in nearly all the traditional fields of geodetic work of position determination, reliability of data acquisition, and processing as well as reality modelling in digital maps. Examples for these applications are intelligent coupling of vehicle and infrastructure, analysis of information processes for mobility services, area covering navigation of rail vehicles and busses for realising computer based operations, etc.

## Project M21 - Providing Strategy for Dynamic Driving Partnerships

Within the project M21, executed by DaimlerChrysler AG and the Government of Baden-Württemberg with the aim of new ways of mobility within the daily rush hours, a dynamic driving partnership service was performed. This service is based on the combination of a routing software and a disposition software.

One of the main tasks of the institute was to analyse and evaluate these two software packages. On their base an alternative disposition strategy to form dynamic car driving partnerships was derived. In contrary to the existing strategy which effected a sequential processing of the individual driving wishes according to booking sequence within the system, the alternative disposition strategy allows a similar handling of driving wishes by a two-step procedure. The first step hereby effects potential driving combinations by related criteria (longer route, more time). Considering in a second step all driver-passenger-quantities within a real disposition date, ambiguities and crucial carrying conditions arise. Solving these ambiguities and crucial conditions is the core of the alternative strategy proposed.

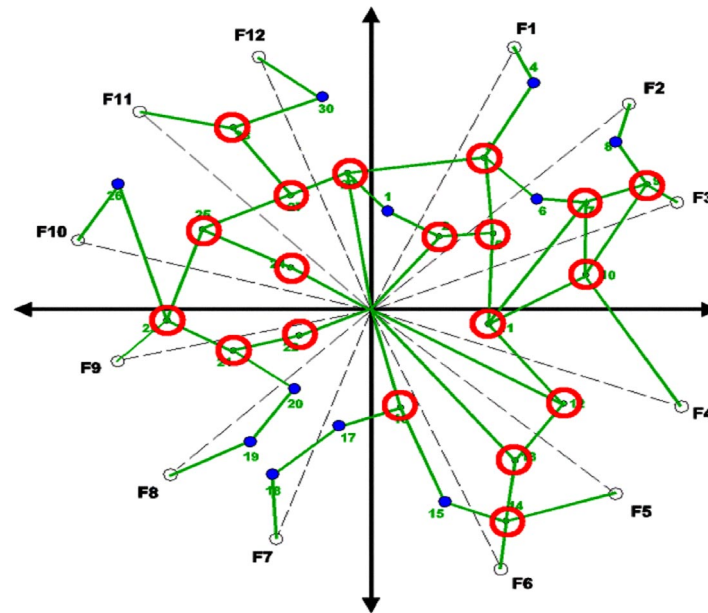

Fig. 7: Ambiguities and restrictions

## GSM-Communication for Prototypical Control Centres

Traffic control centres are prerequisites for controlling vehicle fleets and optimising their profitability. Communication is an important element for the system concept of fleet control. In this context a software written in C/C++ was developed for mobile data transfer by GSM. This software is mainly used for the data transfer of positions and speed profiles on traffic nets to the control centre.

Data transfer is realised by means of three different communication ways:

- ▷ SMS transfer (short messages of GSM-net)
- ▷ transfer by point-to-point-communication
- ▷ safe data transfer by defined protocol.

This communication software is based on AT-commands of Hayes-compatible modems and is especially adapted to handsets of Siemens (S35) and Nokia (N6110).

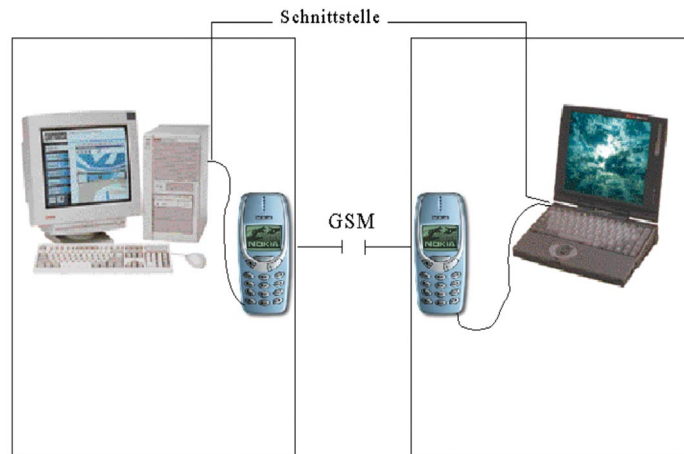

Fig. 8: GSM-communication

## Integration of Tracking- and RBL-Systems

Vehicle fleets in public passenger transport are controlled and supervised by means of computerised operational control centres (RBL). Actual information can be transferred from any vehicle by data radiotelegraphy. Normally position information is gained by logical positioning finding which uses odometers and door opening sensors, and is based on the vehicle route (distance between the stops). The absolute navigation information is related to stationary beacons. Flexible vehicle disposition e.g. in case of road blocking due to incidents is limited by logical positioning. Within

this area of application a commercial navigation systems allowing area-covering navigation was tested. The core of these investigations was the analysis of accuracy and performance of navigation systems. Their use in RBL offers highly improving potential for disturbance management and passenger information. Further tests regarding accuracy requirements and quality characteristics are made within current projects.

This working field refers to the several years of experience in investigations of navigation techniques using map matching. Adaptation of problem-oriented navigation techniques can be developed from experiences with commercial navigation systems. In co-operation with various public transport companies a data model for public passenger transport is developed suitable for navigation as well as for passenger information and also referring to data models of existing information.

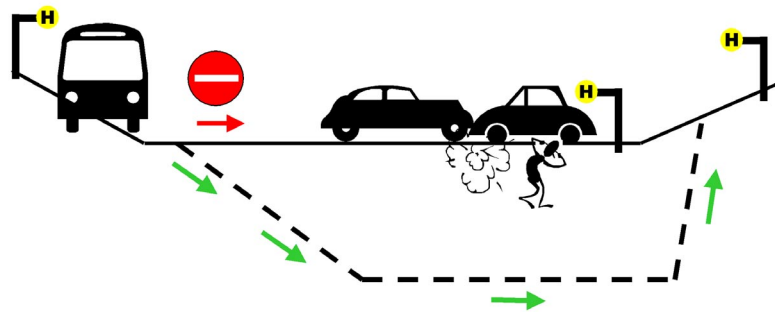

*Fig. 9: Scenario of an incident*

## Project for Virtual Lecturing

Aim of a BMBF-project, called GIMOLUS, is to contribute to improve lecturing by web-based learning modules. In co-operation with university institutes of Stuttgart, Oldenburg, Würzburg and Duisburg an internet-based learning platform is built offering students learning modules in the environmental and GIS education fields including the respective geodata.

An important point of GIMOLUS represents the supply of basic knowledge concerning geoinformation systems and geodata acquisition. On this task the IAGB is working together with the Institute of Photogrammetry, whereby the acquisition and management of geodata is the only task of the IAGB. For this purpose, learning modules for the English lecture "Data Acquisition and Management" of the course „Infrastructure Planning“ will suitably be conceived resp. developed. At the beginning this lecture was reworked with respect to interactive learning divided into the topics: coordinate systems and projections, coordinate transformations, surveying, cartography, geodata market and data processing.

The results are bilingual (German and English) learning modules to be used for various lectures and exercises serving also as an entrance for beginners. For the individual topics learning modules will be designed in Meta language XML, containing flash animation, graphics, etc. These multimedia components are used especially to better illustrate complex problems. Based on the multimedia lectures a learning control is established by interactive learning tools.

## **Activities of Professor K. Linkwitz**

### **Formfinding of Lightweight Structures**

The two-hour-lectures „Analytic Formfinding of Lightweight Structures“ for students of civil engineering, architecture and geodesy were successfully held again. The appertaining practical computer exercises have been performed on windows-NT-computers of the CIP-pool of the department of geodesy. As part of the exercises the students did also interdisciplinary project works in some institutes of civil engineering and architecture.

### **Further lectures of K.Linkwitz**

- a) In the University of Stuttgart As part of the obligatory course „Engineering Geometry and Design“ given to civil engineers in their first semester by the Institute of Construction and Design II, some lectures on the subject „Typical examples of computer-aided geometric design“ were held.
- b) In the Royal Institute of Technology, Stockholm, Sweden Compact Course of 32 hours + additional exercises on „Computer Aided Analytical Formfinding of Lightweight Tension Structures“ for preselected 20 graduate students of architecture.
- c.) Invited lectures on different subjects at: Technical Institute of Kiev, Ukraine; Technical University Donetsk; Ukraine, Harvard University, Cambridge, Massachusetts, USA.

## **Publications 2001**

- Bettermann, R.: Digital Rail -Track Map for Train Positioning. The 3rd International Symposium on Mobile Mapping Technology, Cairo, 2001 Dünisch, M., Kuhlmann, H.: Investigations of accuracy of tracking motorized tacheometers. Proceedings of the 5th Conference on Optical 3-D Measurement Techniques, Vienna, 2001.
- Eichhorn, A. , Möhlenbrink, W.: Identification of physical parameters by means of differential equations in the adaptive dynamic filter model. Proceedings of the 10th FIG International Symposium on Deformation Measurements, Orange, California, 2001
- Eichhorn, A., Möhlenbrink, W., Schittenhelm, H.: Project 'Bumpy Road'. Photogrammetric creation of high resolution digital terrain models of test road surfaces for the durability-simulation

- on virtual car models. Proceedings of the 5th Conference on Optical 3-D Measurement Techniques, Vienna, 2001.
- Forschungsgesellschaft für Straßen- und Verkehrswesen (Authors: Lips, Donat, Fahlbusch, Grünwedel, Kuhlmann, Limbach, Pirner, Rupprecht, Scheffler): Zusätzliche technische Vertragsbedingungen und Richtlinien für die Bauvermessung im Straßen- und Brückenbau, ZTV Verm-StB 01. FGSV-Verlag, Köln, 2001.
- Kuhlmann, H.: Alignment of rails on slab track with robotic tacheometers. The 3rd international Symposium on Mobile Mapping Technology, Cairo, 2001
- Kuhlmann, H.: Importance of Autocorrelation for Parameter Estimation in Regression Models. Proceedings of the 10th FIG International Symposium on Deformation Measurements, Orange, California, 2001
- Kuhlmann, H.; Dünisch, M.: „Geodätisches Meßkonzept für den Einbau und die Kontrolle der Festen Fahrbahn“. VDV-Schriftenreihe, Band 20: Gleisbau 2001 - Planung, Bau, Vermessung - , Verlag Chmielorz, Wiesbaden 2001.
- Linkwitz, K.: About the Education of the Geodesist in Germany, Commemorative Volume of the 75th Anniversary of the Donetsk Technical University, Donetsk 2001, Ukraine.
- Linkwitz, K.: The General Impact of Structural Engineering on Architectural Form, in „Structural Morphology“ of the „Publication Series“ of the Dept. of Building Engineering-School of Architecture, Royal Institute of Technology, Stockholm, 2000 (addendum to publication-list of 2000, as not mentioned there).
- Linkwitz, K. Analytical Formfinding of Tension Structures; Lecture Notes and Exercises, Dept. of Building Engineering-School of Architecture, Royal Institute of Technology. Stockholm, 2001.
- Linkwitz, K. Geodätisch-photogrammetrische Überwachung von Hängen, Böschungen und Stützmauern (Völlige Überarbeitung, zus. mit Willfried Schwarz, Weimar) in Grundbau Taschenbuch, Teil 1, Sechste Auflage, Ernst&Sohn, Berlin 2001.
- Möhlenbrink, W., Kuhlmann, H., Dünisch, M.: Vermessung „Feste Fahrbahn“ - Verfahren für die Vermessung der Bauart „Feste Fahrbahn“, Eisenbahnkalender (EIK) 2002, Seiten 159 bis 176.
- Stark, M.: Informationsanforderung an die Intermodale Routensuche zur Verknüpfung der Verkehrsnetze. DGON Jahreshauptversammlung 2001, Mobilität und Sicherheit, Wolfsburg, 2001. 116-125.
- Wiltschko, Th.: Ein Qualitätsmodell für Informationen - Zur Beschreibung der Informationsqualität infrastrukturgestützter Fahrerassistenzsysteme. DGON Jahreshauptversammlung 2001, Mobilität und Sicherheit, Wolfsburg, 2001. 185-195.
- Wiltschko, Th.: Einsatz eines Geo-Informationssystems zur Analyse des Unfallgeschehens im Ballungsraum. Straßenverkehrstechnik, Heft 6, Bonn: Kirschbaum, 2001. 277-286.



## Diploma Theses

- Marion Friebe: Integration von Geoinformationen in einen ÖPNV-Flottenmonitor mit kartenbasierter Positionsbestimmung
- Tobias Krehl: Untersuchungen des GPS-Systems RS 530 im RTK-Modus unter Einbeziehung der Objektbildung im elektronischen Feldbuch
- Katrin Ramm: Untersuchungen des GPS-Systems MC 1000 zur Beurteilung der Echtzeitfähigkeit bei der Beobachtung bewegter Objekte
- Ralf Schollmeyer: Kombination des GPS-Systems MC 1000 mit Neigungssensoren zur 3D-Positionsschätzung bewegter Objekte in Echtzeit
- Doerte Steup: GIS-gestützter Vergleich von Trajektorien von Fahrzeugen und Ableiten von Merkmalen der zugrunde liegenden Trasse

## National and International Activities in Scientific and Professional Organisations:

Wolfgang Möhlenbrink:

- Member of Deutsche Geodätische Kommission (DGK)
- Member of Deutscher Verein für Vermessungswesen (DVW)
- Member of Deutsche Gesellschaft für Ortung und Navigation (DGON)
- Member of steering committee „Vermessung“ of Forschungsgesellschaft für Straßen- und Verkehrswesen (FGSV) Corresponding member of the „Strategic Advisory Group for Telematic Applications for Transport and Related Services“
- Member of Traffic Research Group at the University of Stuttgart
- Member of Deutsche Verkehrswissenschaftliche Gesellschaft (DVWVG)
- Member of Working Group „Vermessung und Abnahme Feste Fahrbahn“ of Deutsche Bahn AG Coordinator of Working Group „Traffic Guidance and Control“ of IAG
- Speaker of the directory of Centre of Infrastructure Planning of the University of Stuttgart
- Speaker of the Centre of Transportation Research at Stuttgart University (FOVUS).

Ulrich Hangleiter: Member of the IASS (International Association of Shell and Spatial Structures)

Heiner Kuhlmann: Member of Working Group „Vermessung und Abnahme Feste Fahrbahn“ of Deutsche Bahn AG

- Member of Working Group „Absteckung und vermessungstechnische Kontrolle“ of Forschungsgesellschaft für Straßen- und Verkehrswesen (FGSV)
- Member of Working Group „Ingenieurvermessung“ of DVW

## Education - Lecture / Practice / Training / Seminar

Surveying I, II for Civil Engineers (Möhlenbrink)	3/1/3/0
Surveying for Architects (Möhlenbrink)	2/0/1/0
Data Acquisition and Management for Infrastructure Planning (Möhlenbrink)	2/0/0/0
Fundamentals to Surveying for Geodesists (Möhlenbrink)	3/2/0/0
Information Studies for Geodesists II (Wiltschko)	2/2/0/0
Adjustment Theory and Statistics I, II, III (Kuhlmann)	5/3/0/0
Surveying I, II for Geodesists (Kuhlmann)	3/2/0/0
Field Practica in Surveying (Kuhlmann)	10 days
Special Tasks in Surveying (Kuhlmann, Eichhorn)	2/1/0/0
Cadastral Survey (Dünisch)	1/1/0/0
Field Practica in Cadastral Survey (Dünisch)	4 days
Surveying Engineering I, II, III (Möhlenbrink, Kuhlmann)	4/3/0/0
Structural Analysis for Geodesists (Hangleiter)	2/0/0/0
GIS-Supported Design of Road Tracks (Bettermann)	2/0/0/0
Digital and Thematic Cartography (Bettermann)	1/2/0/0
Analytical Formfinding of Lightweight Structures (Linkwitz)	2/0/0/0
Geodetic Seminar I, II (Fritsch, Grafarend, Keller, Kleusberg, Möhlenbrink)	0/0/0/4
Land Consolidation I (Mayer)	3/0/0/0



## Institute of Geodetic Science

Geschwister-Scholl-Str. 24/D, D-70174 Stuttgart,  
 Tel.: +49 711 121 3390, Fax: +49 711 121 3285  
 e-mail: [gis@gis.uni-stuttgart.de](mailto:gis@gis.uni-stuttgart.de) or [SECONDNAME@gis.uni-stuttgart.de](mailto:SECONDNAME@gis.uni-stuttgart.de)  
 url: <http://www.uni-stuttgart.de/gi>

### Head of Institute

Prof. Dr.-Ing. habil. Dr.tech.h.c.mult. Dr.-Ing.E.h.mult. Erik W. GRAFAREND  
 Prof. Dr. sc. techn. Wolfgang KELLER  
 Dr.-Ing. Friedrich KRUMM  
 Prof. Dr. rer. nat. habil. Detlef WOLF (since 26.1.)

Secretary: Anita VOLLMER

### Academic Staff

Dr.-Ing. M.Sc. Amir ABOLGHASEM	Dynamic Geodesy
Dipl.-Ing. Gerrit AUSTEN	Satellite Geodesy
Dr.-Ing. M.Sc. Joseph AWANGE	Positioning
Dipl.-Ing. Karla BÖLLING (since 1.6.)	Satellite Geodesy
Dipl.-Ing. M.Sc. Jianqing CAI	Statistics
Dr.-Ing. Johannes ENGELS	Dynamic Isostasy
Dipl.-Ing. Simone HANKE (until 31.5)	Physical Geodesy
Dipl.-Ing. Andreas HENDRICKS (until 30.6)	Mathematical Geodesy
M.Sc. Lizhi LOU	Satellite Altimetry
Dipl.-Ing. Petar MARINKOVIC (since 27.6.)	Physical Geodesy
Dipl.-Ing. Stephan NAGEL (since 1.9.)	Physical Geodesy
Dipl.-Ing. Tilo REUBELT (since 1.6.)	Satellite Geodesy
Dipl.-Ing. Beate SCHRAMM	Satellite Geodesy
Dr.-Ing. Volker S. SCHWARZE	Physical Geodesy

## Administrative/Technical Staff

Dipl.-Ing. (FH) Wolfgang BAYERLEIN  
Phys. T.A. Margarete HÖCK  
Ingeborg KARBIENER (since 1.2)  
Dipl.-Ing. (FH) Konrad RÖSCH  
Andreas SCHWARZ (until 31.10)

## Guests

Gabriela Vila ANTON (Valencia, Spanien) 27.6.  
Prof. Dr. Alireza ARDALAN (Teheran, Iran) 26.3.-16.4., 5.10.-31.12.  
Dr. Andrzej BORKOWSKI (Wroclaw, Polen) 16.10.-25.10.  
Prof. Fei GAO (Hefei, China) 1.1.-30.9.  
Dr. El Sayed ISSAWY (Kairo, Ägypten) 19.10.-26.10.  
Prof. Dr. Juhani KAKKURI (Helsinki, Finnland) 25.6.-2.7.  
Prof. Dr. Yuki KUROIISHI (Tokio, Japan) 2.10.-31.12.  
Prof. Dr. Burkhard SCHAFFRIN (Columbus, USA) 28.6.-10.9.  
Prof. Dr. Peter VARGA (Sopron, Ungarn) 11.6.-22.6., 5.11.-5.12.  
Prof. Dr. Jozsef ZAVOTI (Sopron, Ungarn) 29.10.-5.11.  
Prof. Dr. Zenko ZENKOV (Sofia, Bulgarien) 22.10.-22.12.

## Additional Lecturers

Prof. Dipl.-Ing. Manfred HINTZSCHE, Fellbach  
Dr.-Ing. Burghard RICHTER, Deutsches Geodätisches Forschungsinstitut, München  
Präsident Dipl.-Ing. Hansjörg SCHÖNHERR, Landesvermessungsamt Baden-Württemberg, Stuttgart

# Research

## Ocean circulation from CHAMP data

Present orbit models for altimeter satellites and models for the stationary sea-surface topography have considerable errors in the length-scale 1000 - 4000 km. Gravity field models derived from CHAMP orbit observations will improve the knowledge about the gravity field in exactly this spectral band. Based on the improved gravity field new orbits for the altimeter satellites could be computed. Since orbit computation is a very complex task, a technology for incremental orbit improvement exclusively due to changes in the gravity field model was developed. With the help of

the incremental orbit improvement technique a radial orbit accuracy of 1cm for a complete repeat cycle of the ERS1/2 satellite could be achieved.

A reprocessing of the ERS1/2 altimeter data based on the improved orbits will be the next step. The final step of the DFG-sponsored project will be the assimilation of the CHAMP-improved geoid model and of the reprocessed altimeter sea-surface heights into the ocean circulation model LSG of the Alfred-Wegener-Institute (AWI) in Bremerhaven.

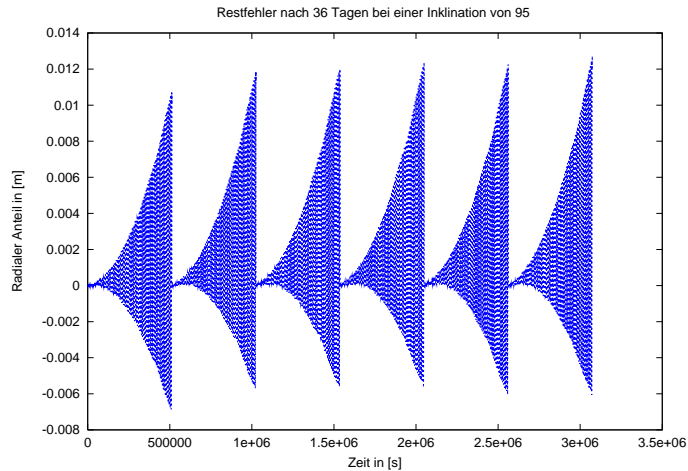

### Fast inverse Kepler Transformation

In the context of orbit analysis of GPS tracked, geodetic LEO satellites geocentric cartesian coordinates, given in a quasi-body fixed reference system, have to be transformed as large-scale data sets into instantaneous Kepler elements. For that purpose a fast algorithm has been developed. The inversion of the nonlinear Kepler transformation, which defines the relationship when computing Cartesian coordinates  $(X, Y, Z)$  from Kepler elements  $(a, e, M, \omega, \Omega, i)$ , has been achieved in a closed form, namely without linearization or iteration. Thus, the inverse Kepler transformation  $\{X, Y, Z\} \rightarrow \{a, e, M, \omega, \Omega, i\}$  computes for three known satellite orbit points given in Cartesian coordinate triples  $(X_1, Y_1, Z_1, X_2, Y_2, Z_2, X_3, Y_3, Z_3)$  the corresponding sets of six Kepler elements  $\{a, e, M_1, \omega, \Omega, i\}, \{a, e, M_2, \omega, \Omega, i\}, \{a, e, M_3, \omega, \Omega, i\}$ :

$t[s]$	$X[m]$	$Y[m]$	$Z[m]$
0	-4233272.5699485224	3297968.0030976869	-4194879.2925180448
30	-4351263.9161406625	3372335.7680159374	-4012405.8085583472
60	-4464317.8556733858	3442876.9210361862	-3825379.4020163519
:	:	:	:

$a[m]$	$e[/]$	$\omega[^\circ]$	$\Omega[^\circ]$	$i[^\circ]$	$M_1$	$M_2$	$M_3$
6823287	0.004001	144.210	257.706	87.277	63.8160	65.7414	67.6668
:	:	:	:	:	:	:	:

## Gravity field determination from kinematic LEO-ephemeris

Three LEO (low earth orbiting) satellite missions have been designed to fly in the next years. One of their main topics is the improvement of existing gravity field models. The first one of this missions, CHAMP - Challenging Minisatellite Payload for Geophysical Research and Application - has already been launched in summer 2000. The twin satellite mission, GRACE - Gravity Recovery and Climate Experiment - should be started in spring 2002. GOCE - Gravity field and Steady-State Ocean Circulation Earth Explorer - should complete the gravity field determination in 2006. Besides various measurement principles applied in the different missions orbit analysis is carried out to determine the low frequency part of the gravity field. Since the LEO orbit ( $h \approx 400$  km) can be tracked with cm-accuracy in the kinematic mode, an algorithm has been designed which enables the determination of the parameters of the Earth's gravity field.

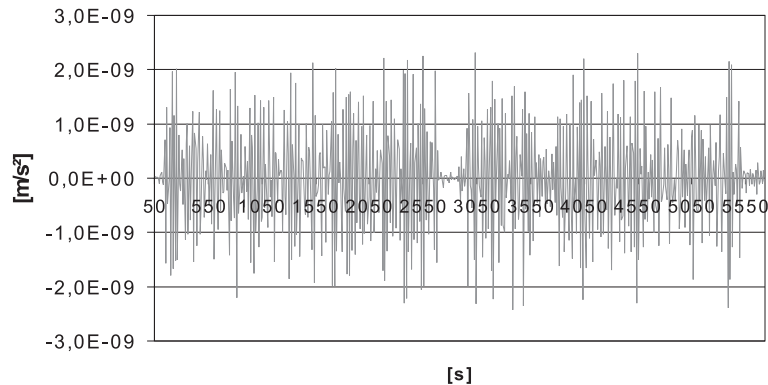

The procedure is as follows: First, the accelerations acting on the satellite are computed by means of the second order functional of Newton interpolation from quasi-inertial GPS tracked LEO ephemeris. Second, the Newton interpolated accelerations are reduced from disturbing accelerations. Third, the reduced accelerations are balanced by the quasi inertial vector of gravitational field intensity. A Cartesian representation of the gradient is applied. The Cartesian gradient is obtained by means of Chain rule from the spherical gradient in order to apply the efficient recurrence relations of the spherical derivatives. The resulting overdetermined system of equations is solved by means of the special linear Gauss-Markov model. Numerical instabilities are diminished via regularisation of type Tikhonov-Phillips, especially the regularisation matrix is based upon Kaula's rule. Both figures illustrate the excellent numerics of the algorithm: The first diagram

exhibits the interpolation error of Newton interpolation for orbit perturbations based upon a spherical harmonics series expansion to degree and order 300/300. The determined acceleration errors are smaller than  $3 * 10^{-9} m/s^2$  and thus lie within the measurement accuracy of a gravimeter. The standard deviation of the estimated coefficients is presented in the second figure. A brilliant signal to noise ratio is received if we notice the accuracy of  $10^{-14}$  in contrast to the coefficient's size of  $10^{-9} - 10^{-10}$ .

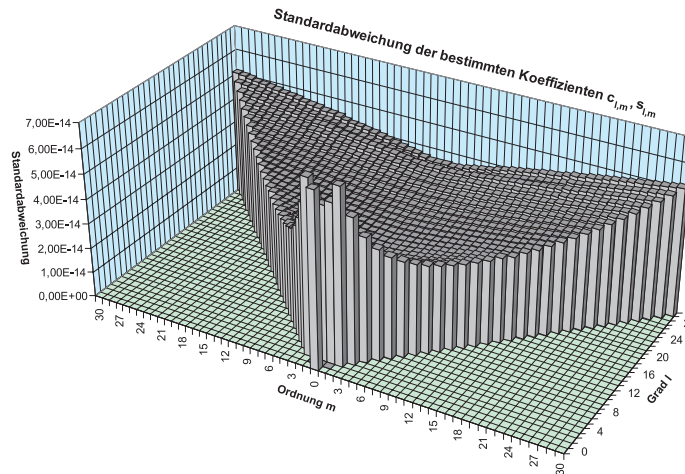

### Variance-covariance transformation from Cartesian coordinate ephemeris to gravity field parameters

As soon as a space gravity spectroscopy has been successfully performed, for instance by means of semi-continuous ephemeris of LEO - GPS tracked satellites, there appears the problem of data validation. It is for this purpose that three-dimensional variance-covariance transformation („error propagation“) has been studied, namely under the hypothesis that an upper bound of variance-covariance matrices of Cartesian coordinate ephemeris can be constructed by means of homogeneous and isotropic Taylor-Karman variance-covariance matrix (criterion matrix of Baarda-Grafarend type).

Homogeneity and isotropy of scalar- and vector-valued functions play an important role in the formulation of criterion matrix of Baarda-Grafarend type (Taylor-Karman variance-covariance matrix). Without getting too deep into extensive theory of scalar and vector fields homogeneity respectively isotropy, can be formulated as the invariant against translation respectively rotation in the statistical sense. If the three-dimensional variance-covariance matrix of Cartesian coordinate ephemeris is considered, the  $3 \times 3$  subblocks characterizes the local error ellipsoids, which are identical in case of homogeneity; and because the isotropy the error ellipsoid degenerates

to sphere. In case of Taylor-Karman structure, error ellipsoid degenerates to sphere of the same size, as a consequence of homogeneity and isotropy.

Furthermore, the basic idea for this concept is that errors of position vectors constitute a stochastic process. Within that concept, satellite orbit of LEO - GPS tracked satellites is an inhomogeneous and unisotropic field of error vectors and the error situation is described by the covariance function. It should be noted, that the error situation of (new) determined position is the best when its error ellipsoid is a sphere (isotropy) with minimal radius and if the error situation is uniform over the complete satellite orbit (homogeneity). That means that the idealized variance-covariance matrix of the LEO-GPS tracked satellite orbit should be homogeneous and isotropic with the result that variance-covariance matrix should be designed by means of Taylor-Karman structure. The correlations between vectors of pseudo-observations are described by two characteristic functions, longitudinal and lateral correlation function. Once we apply the postulate of homogeneity and isotropy to the points on sphere ( $\mathbf{r}$  and  $\mathbf{r}'$  with distance  $r$ ), we get the general expression for the submatrix of cross-covariances between these points within the Taylor-Karman structured criterion matrix equal to:  $\sum_{ik}(\mathbf{r}, \mathbf{r}') + e_m(r)\delta_{ik} + (e_l(r) - e_m(r)) \frac{\Delta x_i \Delta x_k}{r^2}$ ;  $i, k = 1, 2, 3$  with  $\Delta x_1 = r \sin \theta \cos \lambda$ ,  $\Delta x_2 = r \sin \theta \sin \lambda$ ,  $\Delta x_3 = r \cos \theta$ ,  $r^2 = \Delta x_1^2 + \Delta x_2^2 + \Delta x_3^2$ .  $e_l(r)$  denote the longitudinal,  $e_m(r)$  lateral correlation function,  $\delta_{ik}$  is the Kronecker symbol.

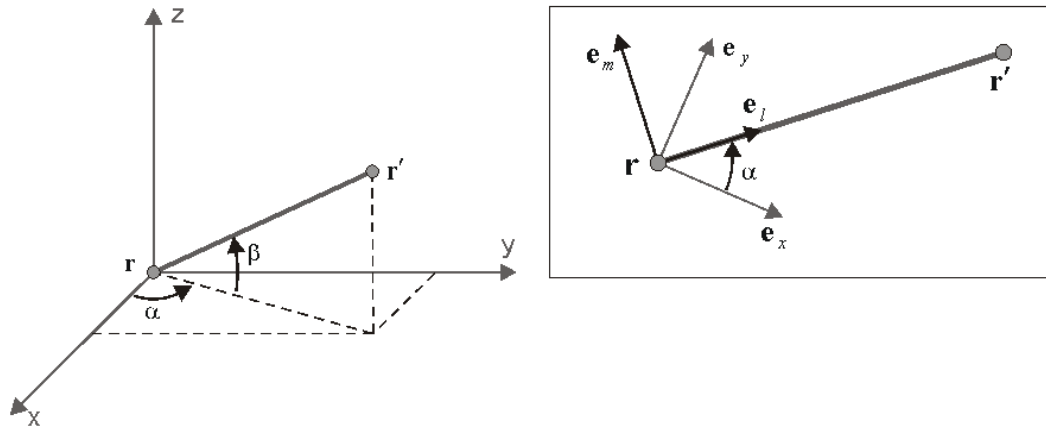

## Geoid Determination

A broad range of geodetic, geophysical, oceanographic and precise engineering applications exist, rendering the need for precise geoid determination methods more pressing than ever. The more accurate the geoid is known, the more problems can be satisfactorily analyzed. The purpose of this project is high-precision multiscale modelling of the geoid from the geopotential val-



ues on the actual earth surface. The following research work forms a first part of the final aim. Disturbing potentials (gravimetric levelling), horizontal and vertical derivations of first and second order (potential measurements, deflections, gravity gradient) derivated from measurements on the topographic earth surface are represented as a solution of the modified Dirichlet boundary value problem on the international reference ellipsoid. The downward continuation written as linear differential equations of first and second kind results in an ill-posed problem. The weighted HAPS inverse (Tykhonov - Philips Regularization, minimal prediction errors included) connects the boundary functionals of the measurements with the disturbing potential on the international reference ellipsoid. Using the ellipsoidal version of Bruns formula the ellipsoidal disturbing potential is converted to geoidal undulations with respect to the international reference ellipsoid.

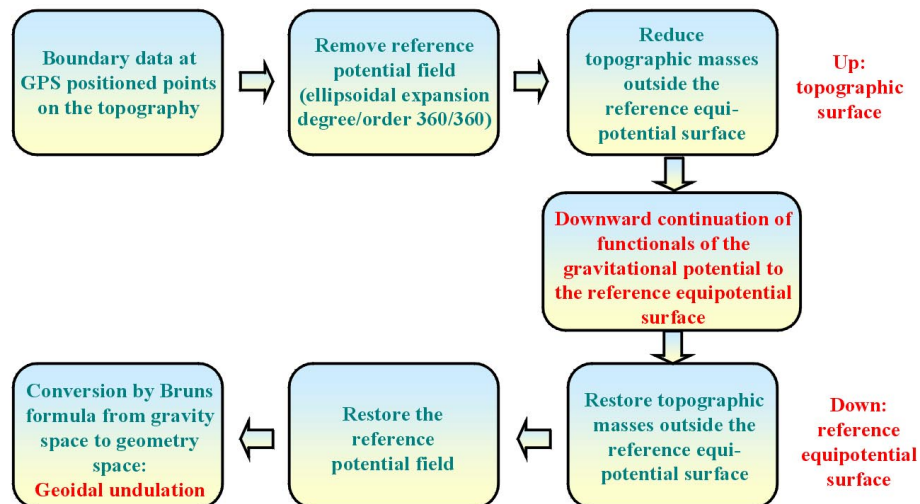

### Wavelet Application in Geodesy and Geodynamics

Wavelets are a recently developed tool for the analysis and interpretation of signals of various types. Compared to Fourier analysis, the standard tool for digital signal processing, wavelets provide two appealing features: (1) localization both in the time- and in the frequency domain and (2) discrete wavelet transformation algorithms, which are numerically even more efficient than the FFT. The DFG sponsored wavelet project aimed at an utilization of these properties in four fields of geodetic applications

## skeleton

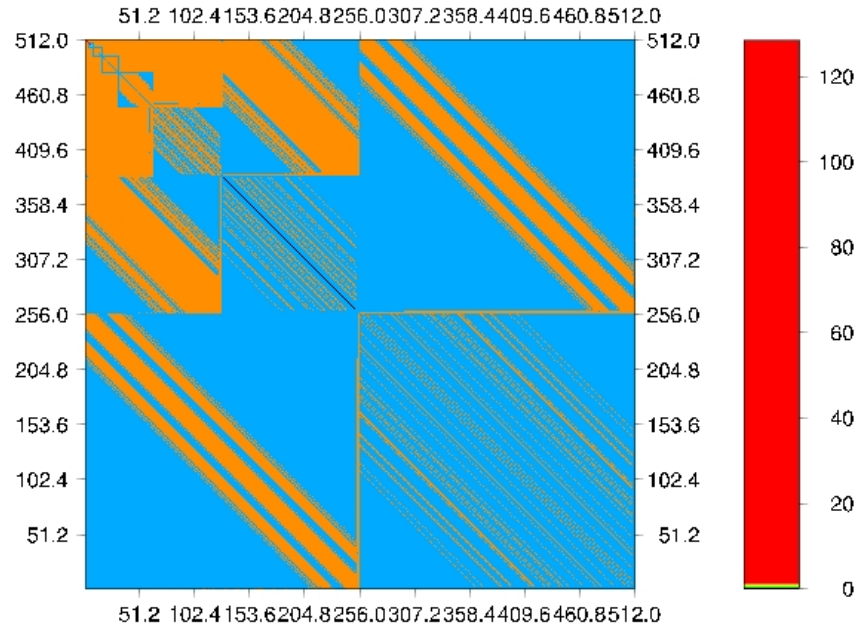

- ▷ 1. Data compression. For an optimal compression of smooth data like geoid undulations or geoid heights the underlying wavelet has to be both smooth and orthogonal. As the results of the investigations a wavelet, derived from the quadratic spline wavelet showed the best overall performance for different types of data. Wavelet analysis and synthesis algorithm tailored to this special wavelet were developed.
- ▷ 2. Operator compression. Weak singularities are a typical feature of kernels of geodetic integral formulas. Using wavelets for their discretization thanks to the localization property of wavelets a very sparse matrix structure can be obtained. Then sparse matrix techniques can be applied for a numerically efficient treatment of the integral equation. Even more: Diagonality of the system matrix can be obtained, if the signal and the data are represented by different specially designed base function systems: wavelets and vaguelettes. For the planar approximation of the Stokes operator a corresponding wavelet-vaguelette pair together with the corresponding decomposition and reconstruction algorithms were developed.
- ▷ 3. Non-stationary collocation. Under the stationarity assumption the Wiener-Kolmogorov equations of collocation theory become convolution equations and can efficiently be solved

by FFT techniques. In reality many data exhibit instationarities and the resulting Wiener-Kolmogorov equations are non-convolution integral equations. Applying the above mentioned operator compression techniques efficient numerical algorithms for the non-stationary case could be developed. For example this technique can be applied to filter a signal with varying noise intensity.

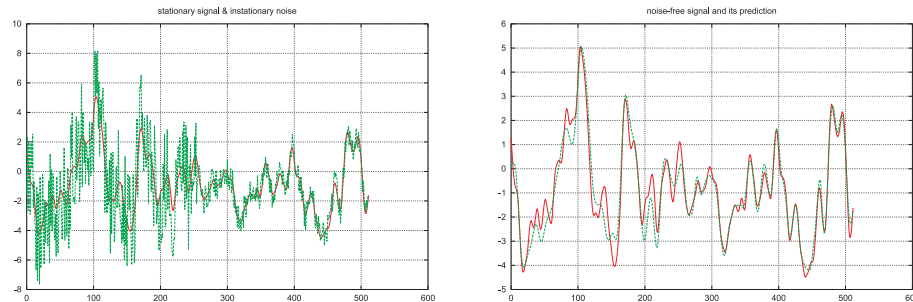

The international cooperation in the field of wavelet application was organized in the framework of the *IAG Special Study Group 4.187*. One important outcome of this cooperation is a wavelet package for the most common wavelet algorithms both in a command-line driven C version as in a platform independent JAVA version. Both versions can be downloaded from the *SSG 4.178 homepage* <http://www.uni-stuttgart.de/iag>.

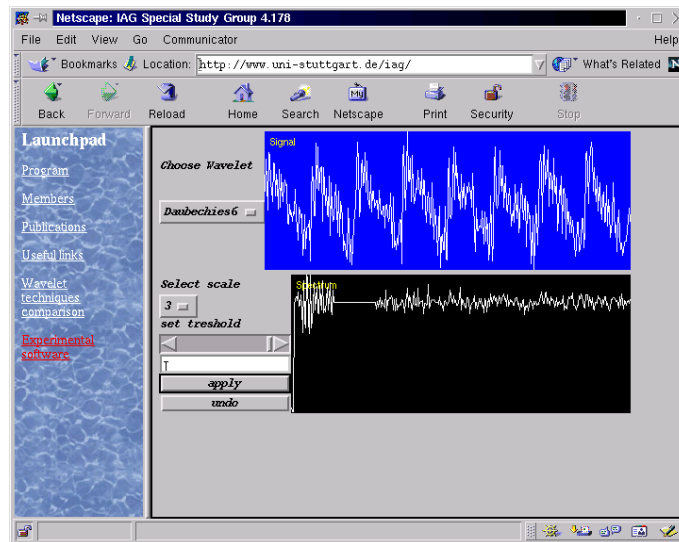

## Numerical Representation of Post-Seismic Displacement Fields

As an alternative to analytical representation of displacement fields due to different deformation sources, for instance dislocation sources and surface loads, a numerical method is tested. Finite element technique, as the proper solution method is applied in computing the displacement field of different Earth models. In some cases, where the analytical solution is available, a comparison is made. The following Earth models have been investigated: (1) Incompressible homogeneous isotropic linear elastic sphere, (2) incompressible pre-stressed homogeneous isotropic linear elastic sphere, (3) incompressible homogeneous isotropic linear viscoelastic sphere, (4) incompressible pre-stressed radially homogeneous isotropic linear viscoelastic sphere and (5) incompressible pre-stressed isotropic linear viscoelastic sphere, with different thicknesses of lithospheric layer. The last model comprises a liquid core, viscoelastic upper- and lower mantle, and a two part elastic lithosphere, an oceanic plate of 150 km thickness, and a continental plate of 50 km thickness. A horizontal slip was formulated on the border of the two lithosphere plates, and the surface displacement field was computed.

## Dynamic Isostasy and Polar Wandering

The aim of this research project is to generalize the common statical Heiskanen-Vening-Meinesz-model to the dynamical viscoelastic case with rotation as well as to a spherical or ellipsoidal boundary geometry, respectively. In particular, the deformation of the earth's body due to surface loading is investigated. Furthermore the temporal variation of the earth's rotation vector due to the incremental inertia tensor is considered, which results from load and deformation.

The viscoelastic case can be treated by Biot's correspondence principle: The Laplace-transformed, linearized equations of motion have for a fixed frequency the same form as the elastic-statical equilibrium conditions. The determining equations for the radius-dependent coefficient-functions of the vector spherical harmonics show characteristic defects, which are due to the quasistatic approximation. Besides the equation of momentum therefore also the equations of angular momentum as well as the system definition of the rotating systems (e.g. Tisserand-system, system of vanishing surface vorticity) are needed.

In contrast to the usual calculation method the displacement components and the incremental rotation vector are determined from a coupled linearized system of equations, taking consequently into account the inertial and the ellipsoidal terms. For the case of a homogeneous, ellipsoidal, viscoelastic, incompressible earth and a surface load, which is characterized by a temporal Heaviside function, the results of the usual method are essentially confirmed. However, a (though small) true polar wander could be demonstrated, which in the framework of the usual method only for layered models appears.

In the period of the report mainly the calculation of layered models was forced. Since there are boundary conditions at the earth's surface as well as at the core-mantle-boundary, the external boundary conditions are propagated downwards analytically. The resulting linear equation system

for the unknown coefficients of the displacement field, the incremental gravity field and the polar motion has to be solved semi-analytically: The elements of the inverted matrix of the linear equation system can be represented as fractions of polynomials in the Laplace parameter  $s$ . The zeros of the nominators and the denominators are determined numerically. Every zero of the denominator corresponds to a fading exponential term in the time domain (inverse Laplace-transformation). The retransformed elements are to be convoluted with the boundary values, which contain the coefficients of the exciting loading potential.

### Effects of Ice- and Water loads on Earth's figure, deformation and gravity field

The causal description of long-period deformations of the solid earth is based on the field theory of gravito-viscoelastodynamics. An important process in this period range is the glacial-isostatic adjustment caused by the melting of the Pleistocene and Recent ice loads. In this connection, the prime research objectives were (1) the further development of the theoretical foundations, (2) the inference of realistic viscoelastic earth models, (3) the improvement of the efficiency of the associated software packages and (4) the application of the models to glacial-isostatic processes. On the one hand, the investigations concentrated here on the determination of the viscosity of the earth's mantle. On the other hand, it was attempted to estimate the influence of isostatically induced vertical movements and geoid changes on the presently observed relative sea-level changes.

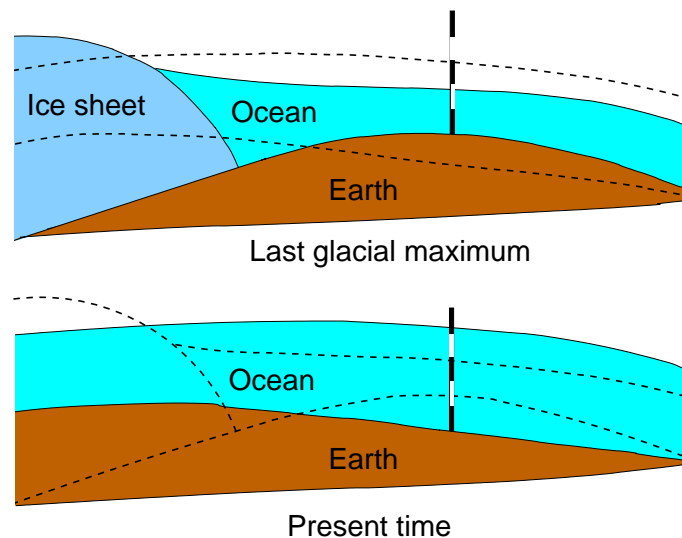

*Vertical movements and geoid changes caused by the melting of ice loads and associated relative sea-level changes at tide-gauge stations. These are to be distinguished from absolute sea-level changes caused by climate changes.*

### Threedimensional GPS/LPS positioning

The challenges brought by the Global Positioning System (GPS) has necessitated the redesign of the hitherto two dimensional local positioning networks into three dimensional positioning mode. The Local Positioning Systems (LPS) procedures such as traversing, resection, intersection "Bogenschnittäre all constrained to be designed in three dimensional mode. The design of the LPS system in three dimensional positioning mode brings with it the three dimensional orientation problem since the LPS systems operate in the Local Level Reference Frame while the GPS system operate in the Global Reference Frame. The solution to the three dimensional orientation problem is achieved by the application of the Simple Procrustes Algorithm or Partial Procrustes Algorithm. In so doing the direction of the local gravity vector namely the astronomic longitude and astronomic latitude are produced thereby alleviating the tedious and tiresome night astronomic observations which are also weather dependent.

The leap from the two dimensional positioning procedures other than giving birth to the three dimensional orientation problem comes along with more complicated non-linear equations which have to be solved for the unknowns. Examples here include the three dimensional distance „Grunert“ equations for three dimensional resection problem, "Bogenschnittëquations, GPS/GLONASS pseudorange equations for the unknown receiver station's coordinates and receiver clock bias, and the minimum distance mapping problem that projects the topographical point onto the (reference) ellipsoid of revolution. The solution to this non-linear equations has been to linearize the equations and use approximate values within the framework of Least Squares Estimation (LSE) and iterate to convergence. To avoid the iterative procedures which depend highly on the approximate values chosen, some of which are difficult to choose as evidenced in some geodetic procedures unlike in photogrammetry, a direct solution of these non-linear equations by using the analytical approaches of Gröbner Bases and Multipolynomial Resultants to manipulate algebraic equations elements of polynomial rings is adopted.

In practice, more observations are normally gathered than is required to solve for the unknowns (also referred to as indeterminate or variables in algebraic language). The P. Werkmeister combinatorial lemma is investigated with the aim of providing an alternative procedure to LSE in solving non-linear Gauss-Markov model but with the advantage of not requiring the initial approximate values and iterative steps. The P. Werkmeister combinatorial is applied to the nonlinear adjustment of GPS observations of type code and phase pseudo-ranges in two steps. In step one, a combinatorial minimal subset of observation is constructed which is rigorously converted into station coordinates by means of Gröbner basis algorithm or Multipolynomial resultant algorithm. The combinatorial solution points in a polyhedron are reduced to their barycentric in step two by means of their weighted mean. Such a weighted mean of the polyhedron points in  $\mathbb{R}^3$  is generated via the Error Propagation law/variance-covariance propagation. The figure illustrates the scatter of 14 combinatorial solution points around the barycentric solution (indicated by a triangle) for the case of six GPS satellites.

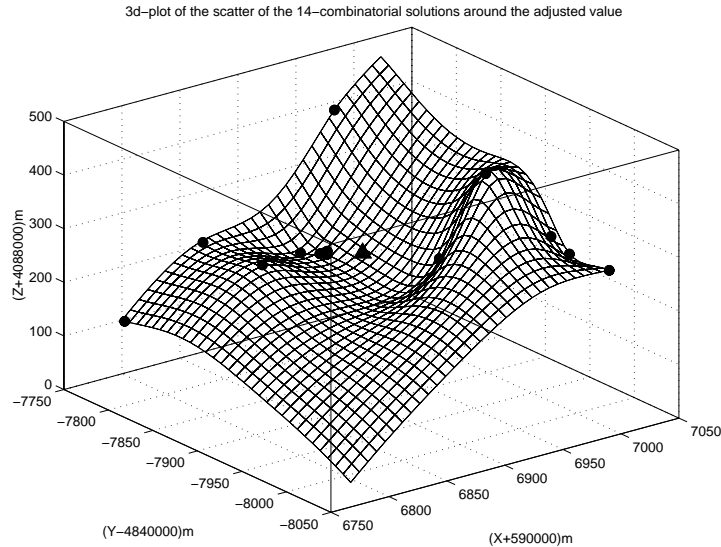

### Hypothesis tests and sampling statistics of the eigenvalues and eigendirections of a random tensor of type deformation tensor

The eigenspace components of random tensors, namely of type deformation tensor, (principal components, principal directions) are of focal interest in geodesy, geophysics and geology. They play an important role in interpreting the geodetic phenomena like earthquakes (seismic deformations), plate motions and plate deformations among others. To develop the proper statistical inference for the eigenspace components of a symmetric deformation tensor is the main purpose of our research project. On the assumption that a strain tensor has been directly measured or derived from other observations, such a two-dimensional, symmetric random tensor of second order is a random tensor  $\mathbf{T}$  which we assume to be a realization from the tensor-valued Gauss normal distribution over  $\mathfrak{R}^{2 \times 2}$  with independently, identically distributed (i.i.d.) tensor-valued observations, but with identical off-diagonal elements. We have proven that the vectorized random tensor has a BLUE estimate which is multivariate normally distributed. The BIQUUE sample variance-covariance matrix is Wishart distributed. The multivariate  $\alpha$ -weighted BLE and optimal determination of the weight factor  $\alpha$  by A-optimal design are developed and are tested and analyzed with numerical results that have been calculated from simulated direct observations of a random strain rate tensor. Since the eigenspace synthesis of a symmetric random tensor is nonlinear in terms of the tensor-valued observations, the respective parameters have to be estimated within a special nonlinear multivariate Gauss-Markov model. We have derived its linearized counterpart for sampling the eigenspace synthesis parameters from the originally nonlinear ob-

ervation equations. The  $\Sigma$ -BLUUE of eigenspace components and their variance-covariance matrix estimate of type BIQUUE are developed. With these results we have firstly successfully estimated the eigenspace components and performed the hypothesis tests about the eigenspace components vector and the variance-covariance matrix of the Gauss-Laplace normal distributed observations of a random deformation tensors.

## List of Publications

- BÖLLING K, HAGEDOORN J M, WOLF D und GRAFAREND E: Berechnung eislaminduzierter Vertikalbewegungen und Geoidänderungen in Südostalaska mit Hilfe viskoelastischer Erdmodelle. Report STR 01/08, GeoForschungszentrum Potsdam, Potsdam 2001
- GRAFAREND E and ARDALAN A: Ellipsoidal geoidal undulations (ellipsoidal Bruns formula): case studies. *Journal of Geodesy* 75 (2001) 544-552
- GRAFAREND E and ARDALAN A: High resolution regional geoid computation. In: Sideris M G (Ed): Gravity, Geoid and Geodynamics 2000. GGG2000 IAG International Symposium Banff, Alberta, Canada, 31.7.-4.8.2001. Springer-Verlag, Berlin-Heidelberg-New York, pp. 301-311
- GRAFAREND E and ARDALAN A: Somigliana-Pizzetti gravity: the international gravity formula accurate to the sub-nanoGal level. *Journal of Geodesy* 75 (2001) 424-437
- GRAFAREND E and HANKE S: The terrain correction in a moving tangent space. *Studia geophys. et geod.* 45 (2001) 211-234
- GRAFAREND E: The spherical horizontal and spherical vertical boundary value problem - vertical deflections and geoidal undulations - the completed Meissl diagram. *Journal of Geodesy* 75 (2001) 363-390
- HAGEDOORN J M, WOLF D and NEUMEYER J: Determination of atmospheric influence on high-accuracy gravity measurements with elastic earth models. In: Sideris M G (Ed): Gravity, Geoid and Geodynamics 2000. GGG2000 IAG International Symposium Banff, Alberta, Canada, 31.7.-4.8.2001. Springer-Verlag, Berlin-Heidelberg-New York, pp. 185 - 191
- KELLER W: A wavelet solution to 1D non-stationary collocation with an extension to 2D case. In: Sideris M G (Ed): Gravity, Geoid and Geodynamics 2000. GGG2000 IAG International Symposium Banff, Alberta, Canada, 31.7.-4.8.2001. Springer-Verlag, Berlin-Heidelberg-New York, pp. 79 - 85
- MARTINEC Z, THOMA M and WOLF D: Material versus local incompressibility and its influence on glacial-isostatic adjustment. *Geophys. J. Int.* 144 (2001) 136-156
- THOMA M and WOLF D: Inverting land uplift near Vatnajökull, Iceland, in terms of lithosphere thickness and viscosity stratification. In: Sideris M G (Ed): Gravity, Geoid and Geodynamics 2000. GGG2000 IAG International Symposium Banff, Alberta, Canada, 31.7.-4.8.2001. Springer-Verlag, Berlin-Heidelberg-New York, pp. 97 - 102



**Doctoral Theses**

AWANGE Joseph: Gröbner Bases, Multipolynomial Resultants and the Gauss-Jacobi Combinatorial Algorithms - Adjustment of Nonlinear GPS/LPS observations (26.11.)

**Diploma Theses**

BÖLLING Karla: Berechnung eislaminduzierter Vertikalbewegungen und Geoidänderungen in Südostalaska mit Hilfe viskoelastischer Erdmodelle (Computation of ice load induced vertical movements and geoid changes in South-East Alaska using viscoelastic Earth models)

CAI Jianqing: Hypothesis tests and sampling statistics of the eigenvalues and eigendirections of a random tensor of type deformation tensor

HÄHNLE Holger: Erstellung eines digitalen Höhenmodells (DHM) mit Dreiecks-Bézier-Flächen (Generating digital height model using triangular Bézier elements)

NAGEL Stephan: Analyse langer Zeitreihen der Polbewegung und Nutation (Analysis of long time series of polar motion and nutation)

**Study Works**

WENGERT Matthias: Vergleich von SAPOS mit Echtzeit GPS mit dem System Leica 530

**Lectures at other universities and at conferences**

AUSTEN G: Harmonic analysis of the Earth's gravitational field from semi-continuous ephemeris of a low Earth orbiting GPS-tracked satellite. IAG 2001 Scientific Assembly, Session C2, Budapest/Ungarn, 3.-8.9.

AUSTEN G: Räumliche Schwerefeldanalyse aus semikontinuierlichen Ephemeriden niedrigfliegender GPS-vermessener Satelliten vom Typ CHAMP, GRACE und GOCE. Jahreshauptversammlung des Vereins „Freunde des Studienganges Geodäsie und Geoinformatik der Universität Stuttgart e. V. (F2GeoS)“, 13.7.

BÖLLING K, HAGEDOORN J, WOLF D and GRAFAREND E: Berechnung eislaminduzierter Vertikalbewegungen und Geoidänderungen in Südostalaska mit Hilfe viskoelastischer Erdmodelle, Geodätische Woche, Köln, 18.-21.9.

BRAUN A, MILLER H, REIGBER C, STORCH H and WOLF D: SEAL: Sea level change: an integrated approach to its quantification, Workshop of the IASC Working Group on Arctic Glaciology, Stockholm, Sweden, 12.02.

BRAUN A, REIGBER C, SCHÖNE T and WOLF D: SEAL: Ein Projekt zur Quantifizierung von Meeresspiegeländerungen. 61. Jahrestagung der DGG, Frankfurt, Tagungskalender, p. 52, 21.03.

- CAI J and GRAFAREND E: Inference on deformation measures. 1st International Symposium on Robust Statistics and Fuzzy Techniques in Geodesy and GIS. ETH Zürich/Schweiz, 12.-16.3.
- CAI J and GRAFAREND E: Statistical inference on deformation measures of the Earth surface derived from space geodetic measurements. IAG 2001 Scientific Assembly, Budapest/Ungarn, 3.-8.9.
- CAI J, GRAFAREND E and SCHAFFRIN B: The S-BLUE of eigenspace components of a symmetric random tensor of second order: Simulated case study: 2-dimensional strain. Geodätische Woche, Köln, 18.-21.9.
- CAI J, GRAFAREND E and SCHAFFRIN B: The  $\alpha$ -weighted BLE of the direct observations of a symmetric random tensor; simulated case study: 2-dimensional strain. Geodätische Woche, Köln, 18.-21.9.
- GRAFAREND E: A new estimate of the time derivative of the geoid gauge? IAG 2001 Scientific Assembly, Budapest/Ungarn, 3.-8.9.
- GRAFAREND E: Analysis of the Earth's gravitational field from semi-continuous ephemerides of a low-Earth-orbiting GPS-tracked satellite of type CHAMP, GRACE or GOCE. IAG 2001 Scientific Assembly, Budapest/Ungarn, 3.-8.9.
- GRAFAREND E: Closed form Green's functions solving three fundamental gradiometric boundary value problems (spherical approximation). IAG 2001 Scientific Assembly, Budapest/Ungarn, 3.-8.9.
- GRAFAREND E: Das Geodätische Weltdatum 2000 im Somigliana-Pizzetti Referenzsystem. Humboldt Club, Technische Universität für Bauingenieur- und Vermessungswesen, Bukarest/Rumänien, 26.-29.2.
- GRAFAREND E: Das Stokessche horizontale Randwertproblem und die Fortsetzung von Lotabweichungen nach unten (sphärische Approximation). Geodätische Woche, Köln, 18.-21.9.
- GRAFAREND E: Datum free deformation analysis of ITRF networks. IAG 2001 Scientific Assembly, Budapest/Ungarn, 3.-8.9.
- GRAFAREND E: Flächendilatation / Flächenscherung und mittlere / Gaußsche Krümmungsänderungen: Analysen aus ITRF-Satellitennetzen im europäischen Raum. Geokinematischer Tag Bergakademie, TU Freiberg/Sachsen, 17.5.
- GRAFAREND E: Geodätische Deformationsanalyse mit ITRF Satellitendaten: Flächendeformation (Metrik, Krümmung). Humboldt Club, Technische Universität für Bauingenieur- und Vermessungswesen, Bukarest/Rumänien, 26.-29.2.
- GRAFAREND E: Geoid, Randwertaufgaben, Quasi-Geoid: Hochaktuelle geodätische Fragestellungen im Zeitalter globaler Positionierungssysteme / in GPS-Zeiten /. Geodätisches Kolloquium, TU Graz, 18.1.

- GRAFAREND E: Geoid, Randwertaufgaben, Quasi-Geoid: hochaktuelle geodätische Fragestellungen im Zeitalter globaler Positionierungssysteme / in GPS Zeiten. Humboldt Club, Technische Universität für Bauingenieur- und Vermessungswesen, Bukarest/Rumänien, 26.-29.2.
- GRAFAREND E: Harmonische Karten. Geodätische Woche, Köln, 18.-21.9.
- GRAFAREND E: Hochaktuelle geodätische Satellitenprojekte: CHAMP, GRACE, GOCE. Humboldt Club, Technische Universität für Bauingenieur- und Vermessungswesen, Bukarest/Rumänien, 26.-29.2.
- GRAFAREND E: Intrinsic deformation analysis of the Earth's surface based on 3D-displacement fields derived from space geodetic measurements, case study: present-day deformation patterns of Europe and Mediterranean Area (ITRF data sets). IAG International Symposium on Recent Crustal Movements, University of Helsinki, Helsinki/Finnland, 27.-31.8.
- GRAFAREND E: Minimaldistanzabbildung der physischen Erdoberfläche auf das Molodensky - Telluroid / Quasi-Geoid in Bezug auf ein Somigliana-Pizzetti-Referenzfeld: Fallstudie Baden-Württemberg und Ostdeutschland. Geodätische Woche, Köln, 18.-21.9.
- GRAFAREND E: Multiresolution analysis of the geoid based upon a GPS collocation solution of data of type (I) gravity potential, (II) gravity intensity and (III) vertical deflections. 26th General Assembly European Geophysical Society, Nice/Frankreich, 25.-30.3.
- GRAFAREND E: Multiresolution analysis of the geoid based upon a GPS collocation solution of data of type (i) gravity potential, (ii) gravity intensity and (iii) vertical deflections. IAG 2001 Scientific Assembly, Budapest/Ungarn, 3.-8.9.
- GRAFAREND E: Quo vadis geodesia: die Zukunft der geometrischen und physikalischen Geodäsie. Humboldt Club, Technische Universität für Bauingenieur- und Vermessungswesen, Bukarest/Rumänien, 26.-29.2.
- GRAFAREND E: Somigliana-Pizzetti gravity - the international gravity formula - accurate to the sub-nanoGal level -. IAG 2001 Scientific Assembly, Budapest/Ungarn, 3.-8.9.
- GRAFAREND E: Spheroidal harmonic analysis to degree / order 1000 / 1000 in the World Geodetic Datum 2000. IAG 2001 Scientific Assembly, Budapest/Ungarn, 3.-8.9.
- GRAFAREND E: Statistical inference on deformation measures of the Earth surface derived from space geodetic measurements. IAG 2001 Scientific Assembly, Budapest/Ungarn, 3.-8.9.
- GRAFAREND E: The collocation model: mixed linear model including fixed effects and random effects, Bayesian estimation, prior information. Institut für Ingenieurvermessung und Messtechnik, TU Graz, 16.1.
- GRAFAREND E: The gauge value of the Gauss-Listing geoid and its time variation : first estimates from the International Baltic Sea Level Project. 26th General Assembly European Geophysical Society, Nice/Frankreich, 25.-30.3.

- GRAFAREND E: The Gauge value of the Gauss-Listing geoid and its time variation: First estimates from the international Baltic Sea level project. IAG 2001 Scientific Assembly, Budapest/Ungarn, 3.-8.9.
- GRAFAREND E: The international gravity formula - accurate to the sub-nanogal level -. 26th General Assembly European Geophysical Society, Nice/Frankreich, 25.-30.3.
- GRAFAREND E: Time evolution of a world geodetic datum. IAG 2001 Scientific Assembly, Budapest/Ungarn, 3.-8.9.
- GRAFAREND E: Variance-covariance propagation (Nonlinear Error Propagation), criterion matrix, Taylor-Karman structure. Institut für Ingenieurvermessung und Messtechnik, TU Graz, 17.1.
- GRAFAREND E: Variance-covariance-component estimation, BIQUUE, Helmert variance-component-estimation, the problem of positive variance components. Institut für Ingenieurvermessung und Messtechnik, TU Graz, 18.1.
- GRAFAREND E: Zwei polare ellipsoidische Koordinatensysteme: Gaußflächennormale Koordinaten versus Jacobisphäroidale Koordinaten. Humboldt Club, Technische Universität für Bauingenieur- und Vermessungswesen, Bukarest/Rumänien, 26.-29.2.
- HAGEDOORN J M and WOLF D: Pleistocene and Recent changes of glaciation in Svalbard: implications for tide-gauge measurements, Research Conference of the ESF on Glacial-Interglacial Sealevel Changes in Four Dimensions, Saint Andrews, England, 01.04.
- HAGEDOORN J M and WOLF D: Pleistocene and Recent changes of glaciation in Svalbard: implications for tide-gauge, GPS, VLBI and absolute gravity measurements, 27th Annual Meeting of the CGU, Ottawa, Ontario, Program and Abstracts, no page, 14.05.
- HAGEDOORN J M and WOLF D: Pleistocene and Recent changes of glaciation in Svalbard: implications for tide-gauge, GPS and VLBI measurements, Minisymposium on Mantle Viscosity: Inferences from Glacial Isostasy and Non-Hydrostatic Geoid, Prague, 26.10.
- HAGEDOORN J M and WOLF D: Rezente Vertikalbewegungen und Meeresspiegeländerungen in Ny-Ålesund, Svalbard, 61. Jahrestagung der DGG, Frankfurt, Tagungskalender, p. 52, 21.03.
- HAGEDOORN J M, WOLF D and THOMA M: Recent vertical movement and geoid change in Ny-Ålesund, Svalbard, 7th International Winter Seminar on Geodynamics, Sopron, Hungary, 21.02.
- HAGEDOORN J M, WOLF D and BRAUN A: Pleistocene and Recent changes of glaciation in Svalbard: implications for tide-gauge measurements, 26th General Assembly of the EGS, Nice, France, Geophys. Res. Abstr., Vol. 3, Session G3.02, 28.03.
- KELLER W: A wavelet approach for the construction of multigrid solvers for large linear systems. IAG 2001 Scientific Assembly, Budapest/Ungarn, 3.-8.9.

- KELLER W: Determination of the Sea-Surface Topography of the Mediterranean by the Combination of Geodetic and Oceanographic Methods. Department of Rural & Surveying Engineering, Universität Thessaloniki, 23.-31.7.
- KELLER W: Instabilities in Hill's equations for orbit computations. IAG Symposium, Budapest/Ungarn, 2.-7.9.
- KELLER W: Zweidimensionale Snake Approximation von Laser-Scanner Daten. Institut für Planetare Geodäsie, TU Dresden, 18.-22.6.
- KLEMANN V and WOLF D: Compressibility and gravitational stability, Minisymposium on Mantle Viscosity: Inferences from Glacial Isostasy and Non-Hydrostatic Geoid, Prague, 25.10.
- KLEMANN V and WOLF D: Glacial isostasy in the presence of a ductile lower crust: implications for estimates of lithosphere thickness, Geodätische Woche, Köln, 18.-21.9.
- KLEMANN V and WOLF D: Global relative sea-level data, Minisymposium on Mantle Viscosity: Inferences from Glacial Isostasy and Non-Hydrostatic Geoid, Prague, 24.10.
- KLEMANN V, WU P and WOLF D: Compressible viscoelasticity: solutions for homogeneous, plane earth models, 26th General Assembly of the EGS, Nice, France, Geophys. Res. Abstr., Vol. 3, Session SE16.01, 29.03.
- KLEMANN V, WU P and WOLF D: Compressible viscoelasticity: stability of solutions for a homogeneous half-space, 27th Annual Meeting of the CGU, Ottawa, Ontario, Program and Abstracts, no page, 14.05.
- KLEMANN V, WU P and WOLF D: Compressible viscoelasticity: stability of solutions for homogeneous plane earth models, 10th International Symposium of the IAG on Recent Crustal Movements, Helsinki, Finland, Abstracts, p. 56, 28.08.
- KLEMANN V, WU P and WOLF D: Compressible viscoelasticity: stability of solutions for homogeneous plane earth models, Geodätische Woche, Köln, 18.-21.9.
- KLEMANN V, WU P and WOLF D: Compressible viscoelasticity: stability of solutions for a homogeneous half-space, 7th International Winter Seminar on Geodynamics, Sopron, Hungary, 21.02.
- MARINKOVIC P: Numerical acceleration computations in satellite geodesy: The implementation of Newton interpolation formula and its accuracy. Geodätische Woche, Köln, 18.-21.9.
- MARTINEC Z and WOLF D: Effects of lateral variations in lithospheric thickness on post-glacial rebound modelling, Geodätische Woche, Köln, 18.-21.9.
- MARTINEC Z, WOLF D and CADEK O: Effects of lateral variations in lithospheric thickness on post-glacial rebound modelling, 10th International Symposium of the IAG on Recent Crustal Movements, Helsinki, Finland, Abstracts, p. 86, 30.08.
- REIGBER C, BRAUN A, MILLER H, VON STORCH and WOLF D: SEAL: Sea level change - an integrated approach to its quantification, 26th General Assembly of the EGS, Nice, France, Geophys. Res. Abstr., Vol. 3, Session G4.01, 26.03.

- REUBELT T: Räumliche Schwerefeldanalyse aus semikontinuierlichen Ephemeriden niedrigfliegender GPS-vermessener Satelliten vom Typ CHAMP, GRACE und GOCE. Jahreshauptversammlung des Vereins „Freunde des Studienganges Geodäsie und Geoinformatik der Universität Stuttgart e. V. (F2GeoS)“, 13.7.
- REUBELT T: Räumliche Schwerefeldanalyse aus semikontinuierlichen Ephemeriden niedrigfliegender GPS-vermessener Satelliten vom Typ CHAMP, GRACE und GOCE. 1. Deutscher GOCE-Workshop, Bonn, 18.9.
- REUBELT T: Räumliche Schwerefeldanalyse aus semikontinuierlichen Ephemeriden niedrigfliegender GPS-vermessener Satelliten vom Typ CHAMP, GRACE und GOCE. Geodätische Woche 2001, Köln, 20.9.
- THOMA M and WOLF D: Glacial-isostatic adjustment in Fennoscandia: indications of larger thicknesses of the Weichsel ice sheet, 26th General Assembly of the EGS, Nice, France, Geophys. Res. Abstr., Vol. 3, Session SE5.01, 26.03.
- WOLF D and HAGEDOORN J M: Pleistocene and Recent changes of glaciation in Svalbard: implications for tide-gauge, GPS and VLBI measurements, 10th International Symposium of the IAG on Recent Crustal Movements, Helsinki, Finland, Abstracts, p. 105, 31.08.
- WOLF D, HAGEDOORN J M and BRAUN A: Pleistocene and Recent changes of glaciation in Svalbard: implications for sea level and vertical motion, Workshop of the IASC Working Group on Arctic Glaciology, Stockholm, Sweden, 12.02.
- WOLF D, REIGBER C, BRAUN A, MILLER H and STORCH H: SEAL: Sea level change: an integrated approach to its quantification, 27th Annual Meeting of the CGU, Ottawa, Ontario, Program and Abstracts, no page, 14.05.
- WOLF D: Glacial isostatic adjustment, SEAL Progress Meeting, Potsdam, 10.05.
- WOLF D: Relative Meeresspiegeländerungen: Indikatoren von Prozessen im System Erdkörper-Landeis-Ozean, Institut für Geowissenschaften, Universität Kiel, 07.09.
- WOLF D: SEAL: Sea-level change: an integrated approach to its quantification, Minisymposium on Mantle Viscosity: Inferences from Glacial Isostasy and Non-Hydrostatic Geoid, Prague, 26.10.
- WOLF D: Viscoelastic field theory, 7th International Winter Seminar on Geodynamics, Sopron, Hungary, 20.-21.02.

### **Guest Lectures and Lectures on special occasions**

- ARDALAN A (Department of Surveying and Geomatics Engineering, Universität Teheran): Ellipsoidal geoidal undulations (ellipsoidal Bruns formula); case studies (3.4.)
- ARDALAN A (Department of Surveying and Geomatics Engineering, Universität Teheran): Ellipsoidal Molodensky telluroid mapping (generalised Bruns formula); case study: Quasi-geoid of East-Germany (5.4.)

- BEYER G (Institut für Planetare Geodäsie, TU Dresden): Approximative Bestimmung von Geländeneigungen und -krümmungen aus wavelettransformierten digitalen Geländemodellen für die Anwendung in GIS (26.4.)
- ILK K H (Institut für Theoretische Geodäsie, Universität Bonn): Zur Lösung des Vertikaldatumproblems (12.1.)
- NAGEL N (Geodätisches Institut, Universität Stuttgart): Analyse langer Zeitreihen der Polbewegung und Nutation (15.11.)
- SCHMIDT M (Deutsches Geodätisches Forschungsinstitut, München): Grundlagen der Gravitationsfeldarstellung mittels sphärischer Wavelet-Funktionen (6.12.)
- SNEEUW N (Institut für Astronomische und Physikalische Geodäsie, TU München): Ein semi-analytischer Ansatz zur Schwerefeldanalyse aus Satellitenbeobachtungen (25.1.)
- SPADA G (Istituto di Fisica della Università di Urbino, Italien): Predicting the motion and shapes of tectonic plates by the constraint of toroidal-poloïdal equipartition (20.12.)
- WITTENBURG R (Institut für Markscheidewesen und Geodäsie, Bergakademie Freiberg/Sachsen): Geokinematik - Methoden, Anwendungen, Probleme (13.12.)

### Activities in National and International Organizations

ENGELS J:

Member Special Study Group 4.189 (IAG): „Dynamic theories of deformation and gravity fields“

GRAFAREND E W:

Member Examining Board „Studiengang Vermessungswesen“

External Examiner, University South East London, UK

External Examiner, University of Nairobi, Nairobi, Kenya

Member German Geodetic Commission at the Bavarian Academy of Science

Member German Physical Society

Member German Geophysical Society

Member Gauß-Society e.V.

Chairman Scientific Committee German Geodetic Research Institute

Member „Deutscher Verein für Vermessungswesen“

Member „Deutscher Markscheideverein“

Member „Auswahlausschuss Alexander-von-Humboldt-Stiftung“

President of the Special Commission Section IV (IAG), SC1: „Mathematical and Physical Foundations of Geodesy“

Chairman Study Group 4.195 (IAG) „Fractals“

Member Special Commission (IAG), SC3: „Fundamental Constants (SCFC)“

Member Special Study Group 5.147 (IAG): „Studies of the Baltic Sea“  
Member Special Study Group 2.109 (IAG) „Application of Space VLBI in the Field of  
Astrometry and Geodynamics“  
Member Royal Astronomical Society  
Member American Geophysical Union  
Member Bernoulli Society  
Member Flat Earth Society

GRAFAREND E W, KELLER W:

Members „Promotionsausschuss“  
Members „erweiterter Fakultätsrat der Fakultät für Bauingenieur- und Vermessungswesen“  
Members „Studienkommission Vermessungswesen“

HENDRICKS A:

Member „Deutscher Verein für Vermessungswesen“  
Member Working Group „Cartography and Geoinformation“, National Standardization  
Institute of Germany

KELLER W:

Member German Mathematical Society  
President Special Study Group 4.187 (IAG) „Wavelets in Geodesy and Geodynamic“  
Member Society of Industrial and Applied Mathematics

SCHWARZE V S:

Member „Deutscher Verein für Vermessungswesen“

WOLF D:

External Examiner, Freie Universität Berlin  
Member Special Commission (IAG)SC1: „Mathematical and Physical Foundations of  
Geodesy“  
Member Commission 14 (IAG): „Crustal Deformation“  
Member Special Study Group 4.189 (IAG) „Dynamic Theories of Deformation and Gravity  
Fields“  
Member Canadian Geophysical Union  
Member American Geophysical Union  
Member European Geophysical Society  
Fellow International Association of Geodesy



**Education - Lecture/Practice/Training/Seminar**

Applied Graph Theory (Grafarend)	2/1/0/0
Adjustment and Statistics III (Grafarend)	2/1/0/0
Differential Geometry for Geodesists (Grafarend)	2/1/0/0
Geodetic Astronomy I,II (Richter)	2/2/0/0
Geodetic Coordinate Systems (Keller)	1/1/0/0
Geodetic Seminar I,II (Fritsch/Grafarend/Keller/Kleusberg/Möhlenbrink)	0/0/0/4
Gravimetry and Earth Tides (Grafarend)	2/1/0/0
Introduction to Geodesy I,II (Grafarend)	2/1/0/0
Map Projections (Grafarend, Krumm)	2/1/0/0
Mathematical Geodesy I,II (Grafarend, Krumm)	2/2/0/0
Numerical Methods in Geodesy (Keller)	1/1/0/0
Physical Geodesy I,II (Engels, Grafarend)	3/2/0/0
Physical Geodesy III,IV (Keller)	4/2/0/0
Potential Theory and Special Functions (Keller)	2/1/0/0
Lab Satellite Geodesy I,II (Keller)	0/0/1/0
Lab Geodesy/Geodetic Astronomy (Grafarend/Richter)	0/0/1/0
Real-Estate Cadastre I,II (Schönherr)	4/0/0/0
Real-Estate/ Property Valuation I,II (Hintzsche)	2/1/0/0
Satellite Geodesy I,II (Keller)	2/2/0/0
Stochastic Processes for Geodesists (Keller)	2/1/0/0
Geodetic Reference Systems (Ardalan)	2/2/0/0
Geodynamics I: Theoretical Foundations (Wolf)	2/0/0/0



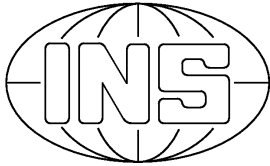

## Institute of Navigation

Geschwister-Scholl-Str. 24/D, D-70174 Stuttgart,  
 Tel.: +49 711 121 3400, Fax: +49 711 121 2755  
 e-mail: [ins@nav.uni-stuttgart.de](mailto:ins@nav.uni-stuttgart.de)  
 homepage: <http://www.nav.uni-stuttgart.de>

### Head of Institute

Prof. Dr.-Ing. A. Kleusberg

Deputy: Dr.-Ing. Karl-Heinz Thiel

Secretary: Helga Mehrbrodt

Emeritus: Prof. em. Dr.-Ing. Ph. Hartl

### Staff

Dipl.-Ing. Jürgen Ming, Akad. Rat	Administration
Dipl.-Geogr. Frank Anselm	Thematic Mapping
Dipl.-Ing. Doris Becker	Navigation Systems
Dipl.-Ing. Felix Butsch	Navigation Systems
Dipl.-Ing. Denise Dettmering	Navigation Systems
Dipl.-Geogr. Thomas Gauger	Thematic Mapping
Ing. grad. Hans-Georg Klaedtke	Remote Sensing
Dipl.-Ing. Roland Pfisterer	Laser Systems
Dipl.-Phys. Manfred Reich	Interferometry
Dipl.-Ing. Oliver Schiele	Navigation Systems
Dipl.-Ing. Wolfgang Schöller	Education
Dipl.-Ing. Jürgen Schmidt	Interferometry
Dipl.-Ing. Hartmut Schuster	Thematic Mapping
Dr.-Ing. Aloysius Wehr	Laser Systems
Dipl.-Ing. Karl Wörz	Interferometry
Dipl.-Ing. (FH) Martin Thomas	Laser Systems
MSC(IP) José Marcelo Zárate Encalada	Remote Sensing

### EDP and Networking

Regine Schlothan

## **Laboratory and Technical Shop (ZLW)**

Dr.-Ing. Aloysius Wehr (Head of ZLW)  
Dipl.-Ing. (FH) Erhard Cyranka  
Dipl.-Ing. (FH) Dieter Schweizer  
Technician Edmund König  
Technician Peter Selig-Eder  
Mech. Martin Böttger

## **External teaching staff**

MSC Imam Mudita  
Dipl.-Ing. Sergey Gurin

## **External teaching staff**

Dr.-Ing. Gerhard Smiatek – Fraunhofer Institute for Atmospheric Environmental Research  
Dr.-Ing. Volker Liebig – Programme Directorate DLR-GE  
Dr.-Ing. Braun – RST Raumfahrt Sytemtechnik AG, St. Gallen

# **Research Projects**

## **Integrity of Satellite Navigation in Airborne Applications**

The DLR (Deutsches Zentrum für Luft- und Raumfahrt) project entitled ISAN (Integrity of Satellite Navigation) investigates the use of GPS or GNSS in all phases of flight especially during approach and landing. The ISAN project involves through participation of a number of collaborating German research institutions and private companies. The Institute of Navigation contributing in studies related to signal multipath and electromagnetic signal interference.

## **Signal Multipath and Electromagnetic Interference**

In high precision applications of satellite navigation systems, a number of common measurement error sources is eliminated or greatly reduced by applying differential corrections provided by a reference station. One of the most severe remaining influences is then the signal multipath effect that corrupts the GPS and GLONASS signals in almost all surroundings, especially in the vicinity

of conducting material. Reflections of the GPS or GLONASS signals from nearby conducting objects can affect the signal at the user location and the ground reference station. New algorithms and software tools are developed and evaluated in order to reduce signal multipath effects.

When satellite navigation systems are used for air navigation, the threat of the reliability, integrity and precision by interfering signal is a very important concern. Within the ISAN (Integrity for Satellite Navigation) project the INS conducts laboratory tests of interference resistance of GPS and GLONASS receivers and field measurements near airports and other possibly electromagnetically contaminated sites.

The INS cooperates with the Deutsche Flugsicherung GmbH (DFS, German Air Navigation Services) in development and deployment of a GNSS Interference Monitoring System (GIMOS). GNSS interference monitoring means to observe signals that could be able to degrade the quality of GPS and GLONASS signals. For this purpose, all signals within the frequency range of GPS and GLONASS are received and their signal properties are evaluated in regular time intervals (e.g. once per second). The goal is to assess the impact on the satellite navigation signal and to gain information about the source of the interference signals.

## **Integrity of Satellite Navigation Data and Differential GPS Data in Land Applications**

Real-time positioning of land vehicles can be usually done by integrated systems consisting of satellite navigation systems, dead-reckoning, and mapmatching. As the accuracy and integrity of these systems is often insufficient for high performance applications, the employment of differential satellite navigation has become an important technology.

One project of the INS is to analyse the availability, accuracy and integrity of the satellite navigation systems and the differential correction data in different environments. Especially in urban canyons, the satellite signals can be shaded or disturbed in such a way that optimal receiver quality can not be guaranteed. In order to give a detailed overview about the performance of differential satellite navigation in different situations, a complete evaluation of the situation will be provided.

## **Comparison of Integrated Airborne Navigation Systems**

Airborne remote sensing systems like Laser Scanners, Digital Line Cameras, Synthetic Aperture Radar (SAR) are systems of choice for fast acquisition of mass topographic data. For georeferencing purpose, these sensor systems rely on external positioning and orientation support of extremely demanding accuracy of centimeter level for position and a hundredth degree or better for exterior orientation angles. Sensor position and orientation data is typically provided by an integrated measurement and processing unit, including a (differential) GPS receiver and an Inertial Measurement Unit (IMU). The achievable accuracy depends largely on the used hardware but also on the quality of data processing algorithms and sensor calibration. As owner of an commercial high precision positioning and orientation system for airborne vehicles, the Institute of

Navigation focused investigations in comparisons to other commercial or non-commercial navigation systems and sensors respectively. Among other things, the Institute of Navigation in cooperation with the Institut für Hochfrequenztechnik und Radarsysteme (DLR) launched an common sensor flight in spring of 2001 in order to compare the recorded and post-processed navigation data of two high-end airborne navigation systems (Applanix POS/AV 510, IGI AEROcontrol IIb). The flight trajectory is pictured in figure 1 below. Since both systems were flown and navigation data recorded simultaneously under operational conditions, the results can be compared directly without any restrictions. The post-processing of the recorded GPS and IMU data is done in a decentralized (or loosely coupled) Kalmanfilter approach, represent by the software packages Applanix PosProc and IGI AEROoffice.

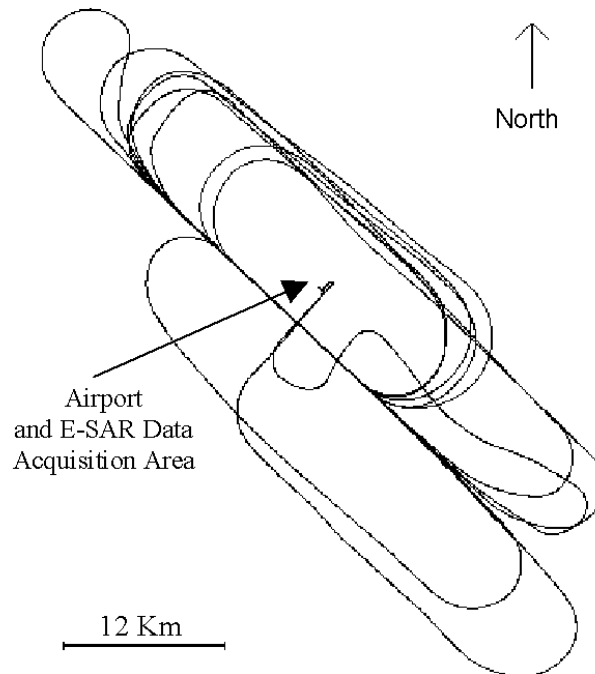

Figure 1: Flight trajectory at DLR area Oberpfaffenhofen, nearby Munich (March, 16, 2001)

	East	North	Alt
Mean	-0.002 m	0.001 m	-0.002 m
Std.Deviation	0.006 m	0.008 m	0.004 m
Max.Deviation	0.016 m	0.025 m	0.017 m
Min.Deviation	-0.020 m	-0.028 m	-0.014 m

*Table 1: Statistics for position differences (1 Hz)*

	Roll	Pitch	Heading
Mean	0.292 deg	-0.043 deg	0.296 deg
Std.Deviation	0.010 deg	0.007 deg	0.026 deg
Max.Deviation	0.023 deg	0.022 deg	0.066 deg
Min.Deviation	-0.031 deg	-0.026 deg	-0.051 deg

*Table 2: Statistics for orientation angle differences (1 Hz)*

For the comparison of the positions and orientation angles, the data were separated into sequences covering „typical flying conditions“ (i.e. the 10 straight lines of E-SAR data acquisition) and „non typical flying conditions“ (i.e. everything else). The following section is restricted to the 10 straight lines of about 2.5 min duration each. First, results are presented at differences in positions and orientation angles at the full second time marks and secondly subsets of position and orientation differences at the full data resolution of 50 Hz are presented. Table 1 indicates, that both integrated trajectories agree in the mean at the millimeter level. Standard deviations are 6 mm, 8 mm and 4 mm for East, North and Altitude, respectively. No systematic behavior is discernible in the position differences. The differences of orientation angles is dominated by the systematic and nearly constant offset from zero, see Table 2. These (mechanical) offsets are to be expected, since they represent differences between the axes of the two different IMUs. The standard deviations for Roll, Pitch and Heading differences are 0.010 deg, 0.007 deg and 0.026 deg, respectively. Overall the agreement is poorer in Heading than in Roll and Pitch - this is to be expected as Heading is less well determined in by an IMU than the other orientation angles. As mentioned above a second type of comparison was done at the full data rate of 50 Hz. The position difference data shows a 10 Hz oscillation horizontally in flight direction with an amplitude of about 3 mm. The possible causes for this oscillation are presently investigated

## Ionospheric Modeling

Information about the temporal and spatial variation of the earth's ionosphere are necessary in order to be able to correct single frequency GPS/GLONASS measurements for ionospheric propagation errors which can easily exceed the 10 m level. Dual frequency GPS/GLONASS receivers

can utilize the dispersive nature of the ionosphere, and directly measure the electron content integrated along the signal path, dubbed Total Electron Content (TEC). Ground based GNSS measurements are not very sensitive to the vertical structure of the ionosphere and do not allow to recover the distribution of free electrons with height. To get three dimensional ionospheric models it is necessary to include dual frequency measurements from one or more space-borne GNSS receivers on Low Earth Orbiter (LEO).

At INS a new algorithm for global 3D ionospheric modeling is developed. To describe the horizontal electron density distribution we use a spherical harmonic function up to degree and order 10. The vertical distribution over each point is approximated by a so called „chapman layer function“. It's a theoretical model with a peak electron content in the height  $h_m$  and with a constant scale height  $H$  (height interval in which the electron content changes by the factor  $e$ ).

We work in a coordinate system which x-axis rotates with the meridian containing the sun, so that time variations caused by different solar radiation intensities could be nearly neglected and the utilization of data collected over time intervals up to some hours is possible. The disadvantage is a non-uniform horizontal distribution of the LEO GPS measurements and the requirement of at least two LEO satellites, in order to be able to describe the horizontal variations of the chapman parameters  $h_m$  and  $H$ . At the moment there exists only one usable satellite: CHAMP. For this reason we have to focus our work on simulations until further satellites will be launched and give us the opportunity to improve our knowledge of the earth's upper atmosphere.

## Scanning Laser Altimeter (ScaLARS)

In the year 2001 ScaLARS data were processed successfully, which were surveyed in Taiwan during a joint measurement campaign with Institute for Photogrammetry of the Cheng Kung University of Tainan. The project was supported by the DAAD (Deutscher Akademischer Auslandsdienst). The most challenging part in processing ScaLARS data was the computing of precise position and orientation data, because most of the time the DGPS-data were very degraded. These data were sampled by the POS/AV 510 platform from Applanix Corporation (of Richmond Canada), which consists of three main components: a dual-frequency GPS-receiver, the POS Computer System (PCS) and a six degree of freedom Inertial Measurement Unit (IMU). The IMU was directly mounted on ScaLARS scanning drive. The left picture shows a laser intensity image in gray levels of the vicinity of Taichung. In the left part of the picture the small Chinese houses can be recognized. The bright thick lines on the right depict a quarry. The right picture visualizes the digital surface model of the same area.



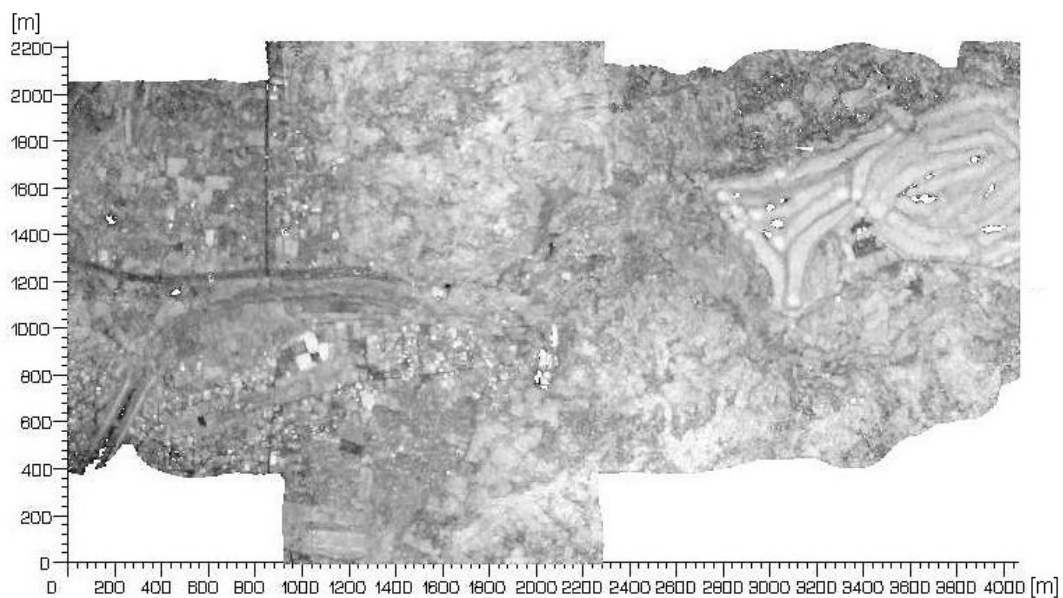

*Intensity Laser Image of an Area in Taichung (Taiwan)*

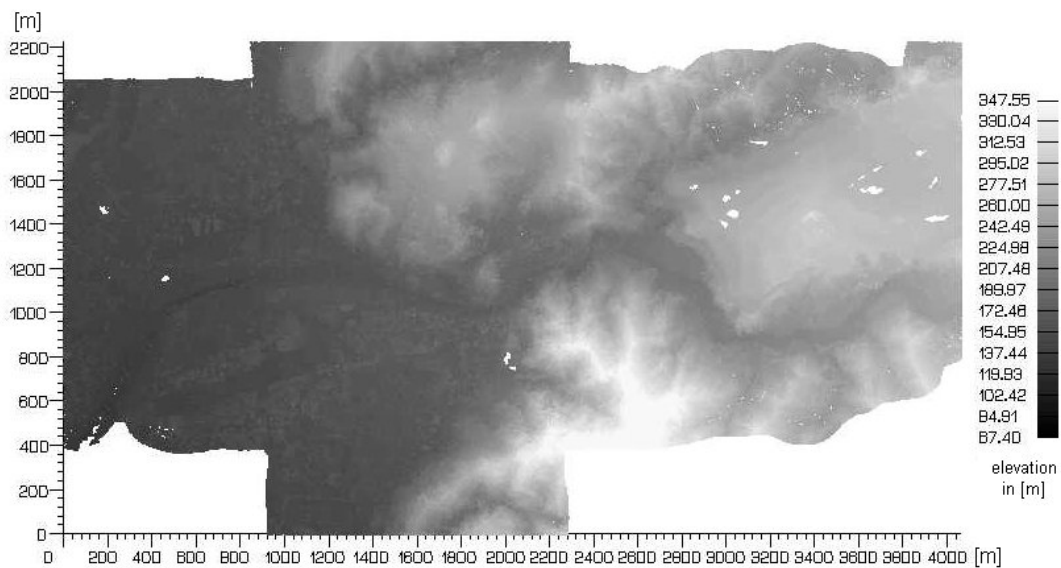

*Corresponding Digital Surface Model*

## Near range applications

The laser scanner for close range applications which can be used in a range interval from 0 m to 5 m was applied for digitizing the housing of a professional camera. The camera will be installed on a light weight airplane for low cost surveying tasks. A stable and precise mounting for the camera is required. Therefore, the front part and the sides were digitized with the laser scanner. In a second step the data will be applied for manufacturing a negative form. In this form the camera should fit so precisely that it could be firmly mounted with a well defined orientation.

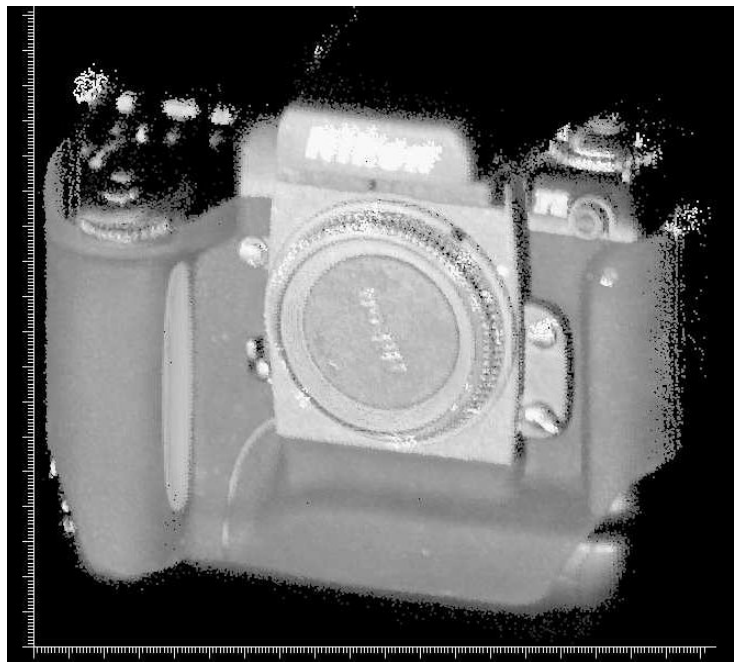

*3D-Projection using laser scanner image data*

## Remote sensing - Validation of SRTM digital elevation products

The Shuttle Radar Topographic Mission (SRTM) flown in February 2000 was the first Single Pass SAR Interferometry (SPSI) Mission operated from space. The mission provided worldwide topography information between +60 and -58 degrees latitude. The acquisition of this unique and valuable dataset is very important for a broad user community e.g. Earth scientists, commercial users

and governmental institutions. Digital elevation models are for example a prerequisite for any process model, e.g. erosion, vegetation distribution, hydrology or climatology. National and local government organizations, scientists, commercial enterprises can use the data for applications as earthquake studies, flood control, transportation and urban planning, enhanced ground-collision warning systems for aircraft and better placement of cell phone towers. Only limited digital topographic maps with varying resolution and datum were available before the SRTM Mission. The only existing global digital dataset has a horizontal resolution of 1 km and a vertical height resolution of 100 m, whereas the specified accuracies of the SRTM are 30 m horizontal and 10 m vertical height resolution in the C-Band resp. 6 m vertical resolution in the X-Band. To achieve this high accuracy, great effort has to be concentrated in the concept for the interferometric calibration, including X-SAR instrument phase calibration and INSAR imaging geometry calibration. The Institute of Navigation is participating in the calibration and validation process for the interferometrically derived SRTM height data using high precise Laser DEM-reference data acquired by the INS-aircraft Laser altimeter.

For a large test area of 50 by 20 km size located in the western part of Thüringen and a smaller test site at the isle of Borkum Laser data acquired by the INS Laser altimeter have been processed in combination with digital information from topographical (TK 10) maps. The laser data were processed with a pixel size of 5 m x 5 m. A classification of the laser data was performed, where ground points are separated from no ground points (buildings, trees, vegetation), allowing an accuracy evaluation for different surface covers - open terrain, urban and forested areas. It could be shown, that the vertical accuracy of the laser DEM is better than 0.5 m with a horizontal resolution of 5 m. It is therefore an ideal tool for the analysis of the SRTM height accuracy as a function of the surface class, vegetation cover, slope orientation and exposition to the sensor. In a first step we compare the laser height information with INSAR-DEM derived from the across track processing of ERS-1 / ERS-2 Tandem data. We use ERS-data of both, ascending and descending passes, to overcome the problems with shadow and overlap areas in mountainous regions, where the SAR-images of only one pass provide no echos or uncorrelated or distorted phase information. The second step is the comparison with SRTM height information. Both steps allow the estimation of the DEM-accuracy for the height data derived with the individual sensors as a function of the different earth cover (buildings, trees, vegetation). The capability of the ERS-INSAR data to provide an accuracy similar to the SRTM data allows us to use the ERS data to fill up the gaps of the SRTM-X-SAR DEMs, providing an overall high quality digital height model.

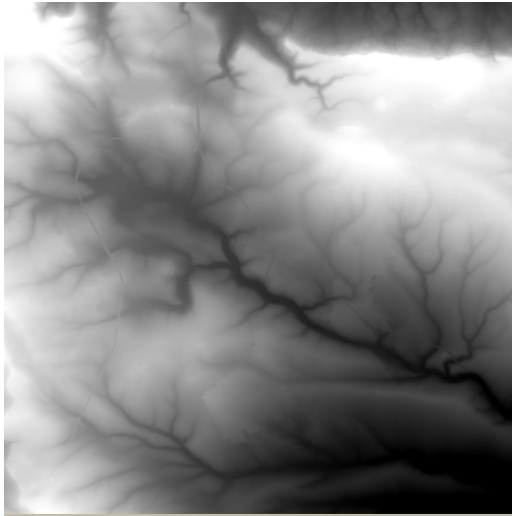

*LASER DDM*

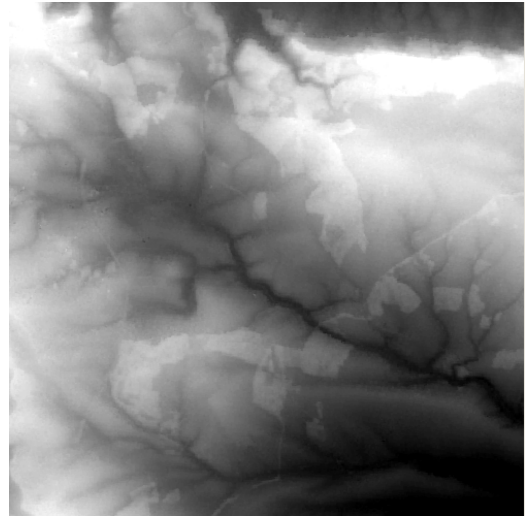

*SRTM DDM*



*difference LASER - SRTM DDM*

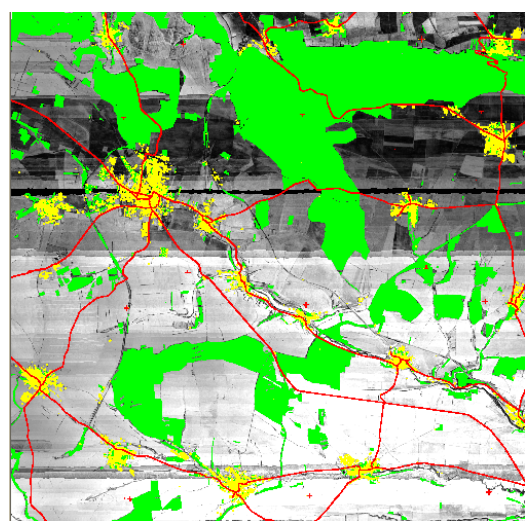

*LASER intensity + TK10 bitmaps*

## Ice Shelf Studies in Antarctica using SAR Interferometry

Remote sensing with ERS-SAR and especially Interferometric SAR (InSAR) e.g. used in Antarctica provides new insights to many phenomena, such as ice flow, topography, tidal movement of ice shelf, grounding line, etc. Of great interest are the ice shelf regions covering large coastal areas. The stability of these floating ice bodies, their mass balance, the energy ex-change process and other factors have great influence on the cold water production for the oceans and on the global climate.

Synthetic aperture radar (SAR) data delivered by the European Remote Sensing Satellites ERS-1 and ERS-2 can be successfully used for interferometry. Traditionally, only the magnitude of the received signal was interpreted. Now, by means of SAR interferometry, the phase related to the distance between satellite and point of reflection of the radar signal on the earth proves to be a valuable source of information. The interferometric phase, i. e. the phase difference between two images acquired from slightly different sensor positions, contains geometrical information allowing the derivation of the three dimensional position of the scatter element.

The interferogram of an ice shelf region shows the well known difficulties of the superimposed effects of topography, vertical tidal and horizontal velocity movements. The complete separation of these effects for large areas is a challenging task and currently a part of our research activities. The co-operation of glaciological and interferometric experts provides an opportunity to address these difficulties, using interferometry and numerical simulation models.

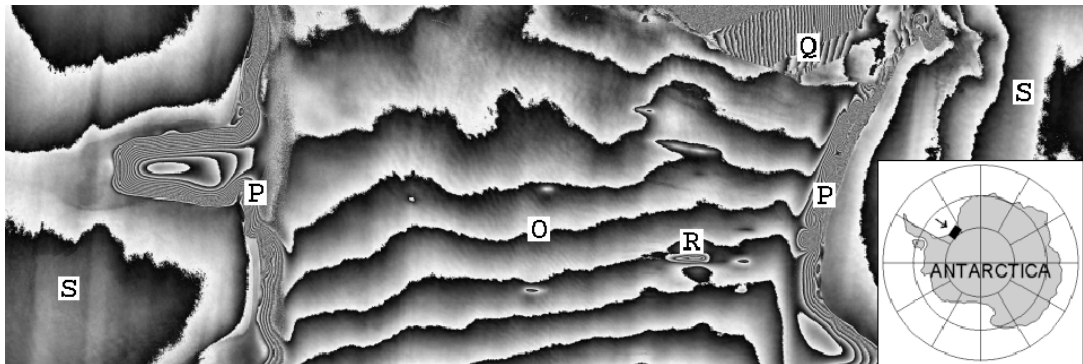

ERS-1 SAR differential interferogram of the northern part of Filchner Ice Shelf, reflecting tidal displacements of the floating portions of the ice body and the surface relief of the grounded portions of the ice body in the investigated area. O: large-scale tilt of the ice shelf due to tidal effects; P: changes in surface slope along the grounding line due to tidal effects; Q: sea ice movement; R: anomalies in the tidal-induced vertical displacement; S: areas of grounded ice.

## Mapping material damages due to air pollutants

The research project „Mapping material damages due to air pollutants“ (BMU/UBA FE-NO. 201 43 205) is funded by Federal Environmental Agency (UBA). A major goal of the project is to produce maps showing the effects of air pollutants on the deterioration of materials. The research project is part of the research activities within the „International Co-operative Programme on Effects on Materials, including Historic and Cultural Monuments“ (ICP Materials). Within ICP Materials the scientific basics of the dose-response-relationships between air pollutants and climate on the one hand and the deterioration of materials on the other hand is established.

The mapping activities are based upon the results of an 8 years materials exposure programme. At 39 test sites in Europe and the Northern America specimen of materials often used to build monuments and buildings are exposed to climate and air pollutant conditions. From the results of the 8 years materials exposure programme dose-response-functions have been derived. These dose-response-functions describe the relationship between climate and air pollutants on the one hand and corrosion rates on the other hand quantitatively. Using the dose-response-functions actual corrosion rates of the materials can be calculated and mapped. The maps indicate the deterioration rate of the materials under actual climate and air pollutant conditions.

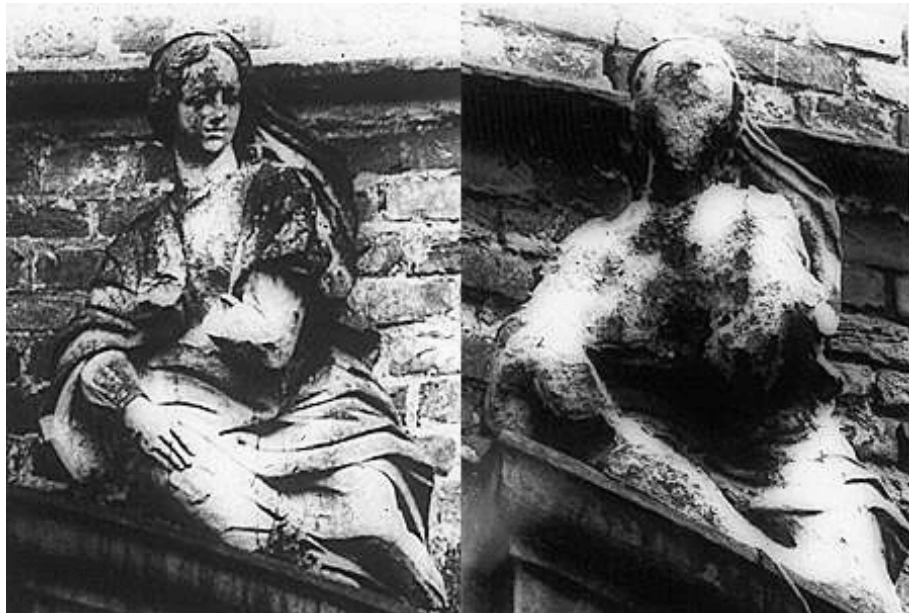

*Effect of air pollutants on materials. Madonna at the portal of Herten castle, Germany (left: 1908; right: 1969)*

## **Mapping of ecosystem specific long-term trends in deposition loads and concentrations of air pollutants in Germany and their comparison with Critical Loads and Critical Levels**

The research project „Mapping of ecosystem specific long-term trends in deposition loads and concentrations of air pollutants in Germany and their comparison with Critical Loads and Critical Levels“ (BMU/UBA FE-NO. 299 42 210) is funded by Federal Environmental Agency (UBA). The aim of the project is to support the German Federal Environmental Agency in calculation and verification of national data to be implemented in European scale Critical Loads and Levels maps. Special interest is put on the detection of long term trends in deposition loads and concentration of air pollutants in Germany. The results of this research project are gained by working in close co-operation with „Gesellschaft für Ökosystemanalyse und Umweltdatenmanagement mbH“ (ÖKO-DATA GmbH) located in Strausberg, Netherlands Organization for Applied Scientific Research (TNO), Appeldoorn, The Netherlands and Netherlands Energy Research Foundation (ECN), Petten, The Netherlands.

Within the project national maps of concentration levels and deposition loads are generated. Maps of deposition loads are used to calculate Critical Loads exceedances in Germany. The calculation of the maps is based upon measurement network data, additional model estimates and high resolution land use maps. Differences of yearly air pollutant input to several ecosystems on the local scale can be identified and exceedances of Critical Levels and Critical Loads within different regions in Germany can be determined.

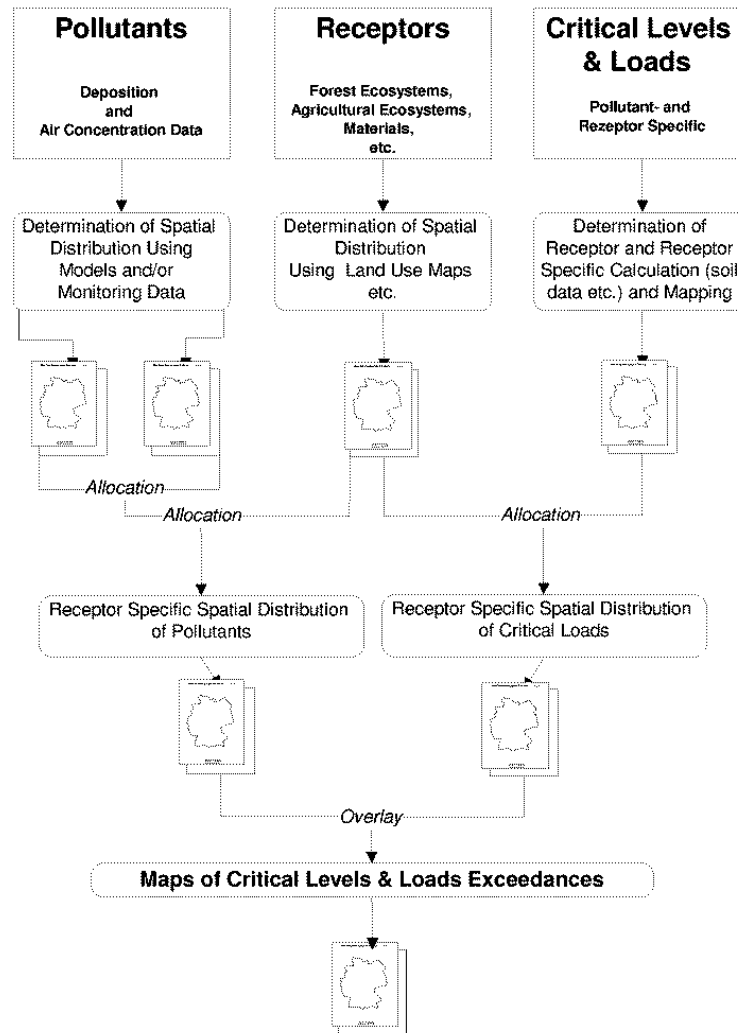

*Principles of mapping Critical Loads and Levels exceedances in Germany*



## Publications 2001

- Anshelm, F., Gauger, Th., Köble, R., Mayerhofer, P., Droste-Franke, B. (2001): Mapping actual corrosion rates and exceedances of acceptable corrosion rates - procedure and results. Kucera, V., Gregor, H.-D. [Eds.]: Mapping Air Pollution Effects on Materials including Stock at Risk. Proceedings of a UN ECE Workshop, Stockholm, Sweden, June 14-16, 2000. Swedish Corrosion Institute (SCI) AB. Bulletin 108E. Stockholm. 27-40.
- Gauger, Th. (2001): Flächendeckende Kartierung der Gesamtdeposition von Stickstoff und potentieller Netto-Säure in Deutschland. In: Niedersächsisches Landesamt für Bodenforschung [Hrsg.]: AcidProgress: das Planungsverfahren für die Forst- und Wasserwirtschaft zur Prognose des Eintritts von Gewässerversauerung in Bewaldeten Einzugsgebieten. Arbeitshäfte Boden 2001/2. S. 69-83. Hannover.
- Gauger, Th., Anshelm, F. (2001): Air Pollutants in Germany: Long Term Trends in Deposition and Air Concentration. Kucera, V., Gregor, H.-D. [Eds.]: Mapping Air Pollution Effects on Materials including Stock at Risk. Proceedings of a UN ECE Workshop, Stockholm, Sweden, June 14-16, 2000. Swedish Corrosion Institute (SCI) AB. Bulletin 108E. Stockholm. 11-26.
- Gauger, Th., Köble, R., Spranger, T., Bleeker, A. Draaijers, G. (2001): Deposition Loads of Sulphur and Nitrogen in Germany. A Comparison of National and international Mapping results. Water, Air, and Soil Pollution. Focus 1. 2001. 353-373.
- Anshelm, F., Gauger, Th., Köble, R., Mayerhofer, P., Droste-Franke, B. (2001): Mapping actual corrosion rates and exceedances of acceptable corrosion rates - procedure and results. Kucera, V., Gregor, H.-D. [Eds.]: Mapping Air Pollution Effects on Materials including Stock at Risk. Proceedings of a UN ECE Workshop, Stockholm, Sweden, June 14-16, 2000. Swedish Corrosion Institute (SCI) AB. Bulletin 108E. Stockholm. 27-40.
- Gauger, Th. (2001): Flächendeckende Kartierung der Gesamtdeposition von Stickstoff und potentieller Netto-Säure in Deutschland. In: Niedersächsisches Landesamt für Bodenforschung [Hrsg.]: AcidProgress: das Planungsverfahren für die Forst- und Wasserwirtschaft zur Prognose des Eintritts von Gewässerversauerung in Bewaldeten Einzugsgebieten. Arbeitshäfte Boden 2001/2. S. 69-83. Hannover.
- Gauger, Th., Anshelm, F. (2001): Air Pollutants in Germany: Long Term Trends in Deposition and Air Concentration. Kucera, V., Gregor, H.-D. [Eds.]: Mapping Air Pollution Effects on Materials including Stock at Risk. Proceedings of a UN ECE Workshop, Stockholm, Sweden, June 14-16, 2000. Swedish Corrosion Institute (SCI) AB. Bulletin 108E. Stockholm. 11-26.
- Gauger, Th., Köble, R., Spranger, T., Bleeker, A. Draaijers, G. (2001): Deposition Loads of Sulphur and Nitrogen in Germany. A Comparison of National and international Mapping results. Water, Air, and Soil Pollution. Focus 1. 2001. 353-373.
- Reich, Manfred: „Validierung von X-SAR SRTM Höhendaten mit Laserhöhen- und Laserintensitätsdaten“, Final Report 2001, Shuttle Radar Topography Mission (SRTM).

- Spranger, T., Kunze, F., Gauger, Th., Nagel, D., Bleeker, A., Draaiers, G. (2001): Critical Loads Exceedances in Germany and their Difference on the Scale of Input Data. Water, Air, and Soil Pollution. Focus 1. 2001. 335-351.
- Sutton, M. A., Asmann, W.A.H., Ebermann, Th., van Jaarsveld, J.A., Acker, K., Aneja, V., Duyzer, J. Horvath, L., Paramonov, S., Mitosinkova, M., Sim Tang, Y, Achermann, B., Gauger, Th., Bartnicki, J., Neftel, A., Erismann, J.W. (2001): Establishing the Link between ammonia emission control and measurements of reduced nitrogen concentrations and deposition. UN/ECE Ammonia Expert Group. Berne, 18-20 September 2000. Proceedings. Swiss Agency for the Environment, Forests and Landscape (SAEFL). Environmental Documentation No. 113. Air. Berne. 57-84.

## Presentations 2001

- Anshelm, F.: Mapping actual corrosion rates in Germany.- UN ECE Convention on Long-range Transboundary Air Pollution. 11th CCE Workshop on Mapping Critical Loads and Levels. 24 - 27 April 2001, Bilthoven, The Netherlands.
- Anshelm, F.: Mapping AOT60 and WHO Air Quality Guideline value for the protection of human health.- UN ECE Convention on Long-range Transboundary Air Pollution. 17th Meeting of the Task Force on Mapping Critical Levels and Loads (ICP Mapping). 7 - 9 May 2001, Bratislava, Slovak Republic.
- Anshelm, F. and Gauger, Th.: Mapping Acceptable Levels/Loads for Effects of Air Pollutants on Materials in Germany.- UN ECE Convention on Long-range Transboundary Air Pollution. 17th Meeting of the Task Force ICP Materials. 11 - 13 June 2001, Dübendorf, Switzerland.
- Anshelm, F.: Kritische Belastungsgrenzen für Materialien. Festkolloquium 'Critical Loads and Levels - a joint concept of science and policy to protect human health and the environment' zu Ehren des 60. Geburtstages von Heinz-Detlef Gregor. 26 October 2001, Berlin, Germany.
- Gauger, Th.: Progress made in mapping deposition loads in Germany.- UN ECE Convention on Long-range Transboundary Air Pollution. 11th CCE Workshop on Mapping Critical Loads and Levels. 24 - 27 April 2001, Bilthoven, The Netherlands.
- Gauger, Th.: Long-term trends of air pollution and Critical Loads Exceedances in Germany.- UN ECE Convention on Long-range Transboundary Air Pollution. 17th Meeting of the Task Force on Mapping Critical Levels and Loads (ICP Mapping). 7 - 9 May 2001, Bratislava, Slovak Republic.
- Gauger, Th. and Nagel, H.-D.: Critical Loads and Levels Ansatz in Deutschland. Festkolloquium 'Critical Loads and Levels - a joint concept of science and policy to protect human health and the environment' zu Ehren des 60. Geburtstages von Heinz-Detlef Gregor. 26 October 2001, Berlin, Germany.

Gauger, Th.: Method and preliminary results in mapping deposition loads in Germany. International Cooperative Programme on Modelling and Mapping. Trilateral Meeting between Poland, Czech Republic and Germany. 29 October 2001, Neuschönau, Germany.

Reich, Manfred: „Calibration of X-SAR/SRTM elevation data with laser height and intensity data“. X-SAR/SRTM PI meeting, 9. Oktober 2001, Deutsches Fernerkundungs-zentrum (DFD) - DLR Oberpfaffenhofen.

## Diploma Theses

Rath, Michael (2001): „Leistungsvergleich zwischen den GPS Auswerteprogrammen GeoGenius und GrafNav/GrafNet“

## Events

2nd European Applanix POS User Workshop, Stuttgart November 23-24, 2001

## Activities in National and International Organizations

Alfred Kleusberg

- Fellow of the International Association of the Geodesy
- Member of the Royal Institute of Navigation
- Member of the German Institute of Navigation
- Adjunct Professor, University of New Brunswick, Canada
- Adjunct Professor, University of Main, USA
- Adjunct Professor, Laval University, Canada

## Education (Lecture / Practice / Training / Seminar)

Introduction to Navigation (Kleusberg)	2/0/0/0
Flight Navigation und Avionic (Schöller, Wehr)	2/0/0/0
Introduction to Electronics for Geodesists (Wehr)	2/1/0/0
Electronics for Geodesists (Wehr)	2/1/0/0
Remote Sensing I (Thiel)	1/1/0/0
Remote Sensing II (Smiatek)	1/1/0/0
Navigation I, II (Kleusberg)	3/1/0/0
Navigation III / Radartechniques (Braun)	2/1/0/0
Electrical Engineering for Geodesists (Schöller)	3/1/0/0
Practical Course in Navigation (Schöller)	0/0/2/0
Practical Course in Electrical Engineering (Wehr, Selig)	0/0/2/0
Practical Course in Electronics (Wehr, Selig)	0/0/4/0

---

Applied Kalman Filtering (Schöller)	2/0/0/0
Software Development (Fritsch, Grafarend, Keller, Kleusberg, Möhlenbrink)	0/0/4/0
Geodetic Seminar I, II (Fritsch, Grafarend, Keller, Kleusberg, Möhlenbrink)	0/0/0/4
Satellite Systems and Programming in Remote Sensing (Liebig)	2/0/0/0



## Institute for Photogrammetry

Geschwister-Scholl-Str. 24/D, D-70174 Stuttgart,  
Tel.: +49 711 121 3386, Fax: +49 711 121 3297  
e-mail: [firstname.secondname@ifp.uni-stuttgart.de](mailto:firstname.secondname@ifp.uni-stuttgart.de)  
url: <http://www.ifp.uni-stuttgart.de>

### Head of Institute

Prof. Dr.-Ing. Dieter Fritsch  
Deputy: Dr.-Ing. Norbert Haala  
Secretary: Martina Kroma

Emeritus: Prof. i.R. Dr. mult. Fritz Ackermann

### Working Groups at the ifp:

#### Photogrammetry and Remote Sensing

Head: Dr.-Ing. Norbert Haala  
Dipl.-Ing.(FH) Werner Schneider  
Dipl.-Phys. Heiner Hild  
Dipl.-Geogr. Timo Balz

Multisensor Photogrammetry  
Digital Photogrammetry Lab  
Automatic Image to Map Registration  
Photogrammetry and Remote Sensing

#### Geographic Information Systems

Head: Dr.-Ing. Volker Walter  
Dipl.-Ing. Jan-Martin Bofinger  
Dipl.-Inform. Martin Kada  
Dipl.-Geogr. Steffen Volz  
Dipl.-Geogr. Heike Weippert

GIS and Remote Sensing  
GIS and CAFM  
3D-Visualisation  
Location Based Services  
Multimedia GIS Training

#### Optical Inspection

Head: Dipl.-Inform. Jan Böhm  
Dipl.-Ing. Jürgen Hefe

Spatial Segmentation and Object Recognition  
Optical Inspection

## Sensor Integration

Head: Dr.-Ing. Michael Cramer  
Dipl.-Ing.(FH) Markus English  
Dipl.-Ing. Dirk Stallmann  
Dipl.-Ing. Darko Klinec

GPS/INS-Integration  
Sensor Laboratory  
Aerial Triangulation  
Pedestrian Navigation

## External teaching staff

Dipl.-Ing. Volker Schäfer, Ltd. Verm. Dir., Wirtschaftsministerium Baden-Württemberg  
Dr.-jur. F. Schwantag, Reg. Dir., Landesamt für Flurordnung und  
Landesentwicklung Baden-Württemberg

# Research Projects

## Photogrammetry and Remote Sensing

### Automatic Registration of Remote Sensing Data

The still growing number of remote sensing imagery raises the need of a reliable automatic system to solve the georeferencing problem. Integration of GPS and INS measurements to determine the exterior orientation is an operational strategy for airborne imaging systems, the same holds true for direct georeferencing for space borne systems based on GPS/INS and star tracker measurements. However, reduced ground control is also required within this context. Additionally, in operational processes, satellite images are up to now mainly georeferenced by manual measurements.

In order to enable an economic provision of ground control, a fully automatic system for the registration of satellite imagery with vector GIS data was developed. The implemented approach is based on polygonal objects which are extracted from the image by region growing segmentation, and from the GIS data set by merging of polygons with the same object class. Based on absolute affine invariant features, corresponding pairs of objects are determined by a backtracking depth-first tree search algorithm. Investigations proved the robustness and discrimination

power of the used absolute affine invariants. Within the tree search algorithm, unary and binary constraints are applied in order to find a consistent subset of polygon pairs from all matching hypotheses. Furthermore, a coarse global affine transformation is determined in this step. Based on this transformation, all hypothesis being consistent with the global transformation are determined in a verification step. An individual affine transformation for each object pair is computed by using the formalism of standard positions. The individual transformations are refined for each verified sensor-model polygon pair in a refinement step. Finally, homologous points (GCPs) with prefixed standard deviation of the residuals are extracted from the polygon boundaries.

The following figures show an exemplarily application of the whole process to a 25km x 20km section of the German ATKIS Vector data base. In a first step forest polygons are extracted from the ATKIS database and matched against the corresponding regions of the original SPOT PAN data. Finally ground control points are generated based on an iterative closest point algorithm at subpixel accuracy.

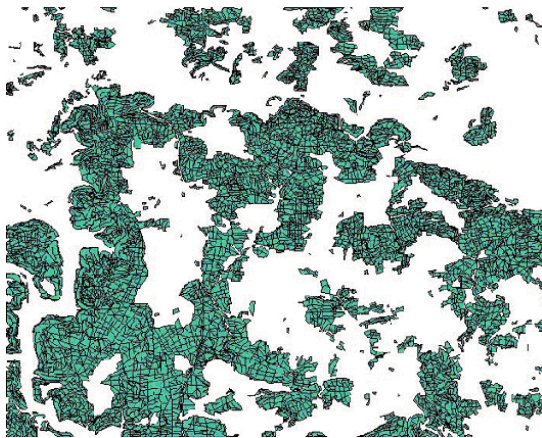

*Fig. 1: ATKIS forest polygons in 25km x 20km test area.*

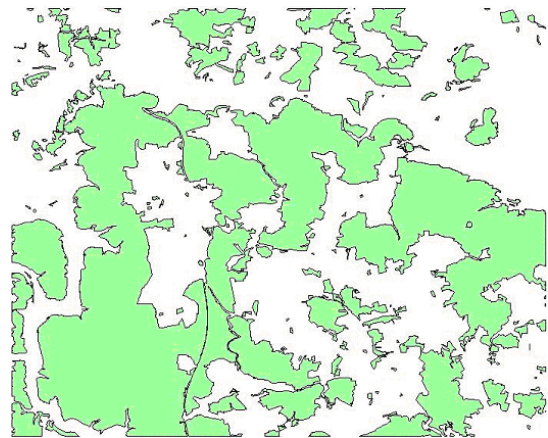

*Fig. 2: Merged ATKIS forest polygons as input for automatic GCP location*

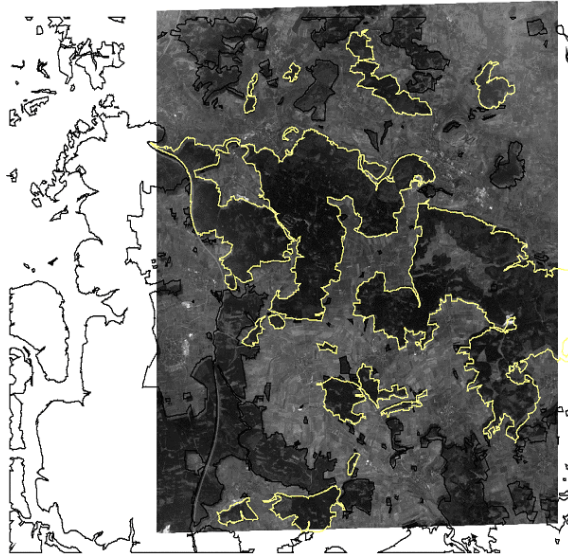

*Fig. 3: GIS datasets transformed to SPOT scene with determined global transformation*

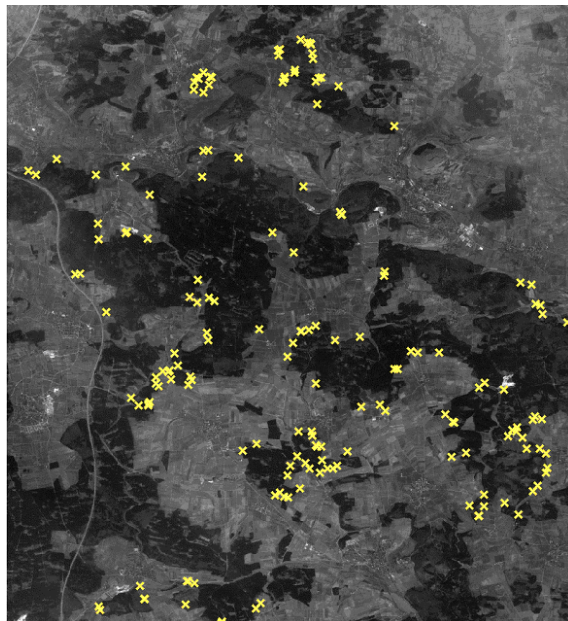

*Fig. 4: SPOT test area with automatically detected GCPs*



## **Sustainable Development for Integrated Landuse Planning**

The joint German-Chinese research project SILUP (Sustainable Integrated Land Use Planning) aims in developing and implementing a strategy for sustainable land use planning in a rapidly developing study area south of Nanjing, Jiangsu province, China. Because of the rapid development of the site there is a high pressure for land to be transferred from agricultural use into industrial use. Sustainable development in this context means simultaneously respecting the ecological and socioeconomical value of land, judging it and finding the best suited areas to fulfil the demands. For the ecological side, water management aspects as well as biodiversity and soil aspects are of importance. Areas with important functions for groundwater recharge, surface water runoff, biotopes and the like have to be identified and protected from land use change. The output of the SILUP system is a categorized map which shows land use planners, where agriculturally used areas can be a target for further development. This paper presents the integration of various data sources into a consistent spatial data base which was the working fundament of all institutes participating in the SILUP project. The emphasis of the project work was not set in the highest possible degree of automation for each task but on the generation of a consistent data base which is usable by all project partners with their strongly different demands on accuracy and attribution. The SILUP project could be finished successfully and was highly acknowledged by the German BMBF (Federal Ministry for Education and Research) and the UNESCO.

The project team consists of a hydraulic modeling group, a socioeconomic group, an ecology group and a GIS / Remote Sensing group. For each group there is an institute from Stuttgart and one or two from Nanjing. The role of ifp is - together with the GIS group of the Nanjing University - to provide the required spatial database, which consists of the layers representing transportation network, surface water, elevation data (DEM, aspect map, slope map), administrative units, settlement centers, planning related information, orthoimages. Most of this information was extracted from SPOT PAN and multispectral data; overall two georeferenced panchromatic and two georeferenced multispectral scenes were available for the project. Based on the multispectral data, multispectral classification was carried out in a combined unsupervised-supervised hierarchical strategy in order to obtain actual land cover information. Together with topographic data, which was updated manually from the panchromatic scenes, a vector land use map was created.

## **Virtual City Models**

For the 3D reconstruction of urban scenes a system is available, which is based on the use of height data from airborne laser scanning and the ground plans of buildings provided by an existing 2D GIS or map data. Since the 3D reconstruction is based on an existing GIS, also information on usage, owner etc. can easily be linked to the reconstructed buildings. After the generation of the 3D model, aerial or terrestrial images are mapped against the faces of the reconstructed buildings to provide photo texture for realistic visualization. Meanwhile laser scanner systems are already

combined with digital cameras thus this information is readily available and can be integrated automatically. Current developments are aiming on the automatic orientation of terrestrial images in urban environment, which is a prerequisite for the automatic texture mapping based on this type of imagery.



*Fig. 5: Virtual City Model*

### **Digital Photogrammetric Laboratory**

The digital photogrammetry and remote sensing group is cooperating very closely with a number of companies and institutions for the development of a new generation of digital airborne and space borne photogrammetric systems. In addition to the availability of the required soft- and hardware (photogrammetric workstations, scanner, own software developments) in the digital photogrammetric laboratory, a test site close to Stuttgart has been established and is maintained by the ifp. Within this test site a large number of well defined signalized points are available which are regularly used for accuracy tests of commercial systems like digital airborne cameras, integrated systems for direct georeferencing or airborne laser scanners.

## Geographic Information Systems

### Automatic update of GIS

Digital spatial data are underlying strong temporal changes. The typical approach of updating these changes is to check the data manually for their correctness by superimposing them on up-to-date orthophotos. The update cycles of large data sets are in the range of several years. At present shorter update cycles are not to perform for two reasons. The manual inspection of the data is very cost- and time-consuming and aerial photographs for large areas are very often not available in the needed time intervals. However, a decisive turn can be seen in data availability. With new satellite systems, it will be possible to provide up-to-date high resolution orthophotos in short time periods and high quality in the near future.

The used approach consists of two steps. In a first step the remote sensing data have to be classified pixel wise into different land use classes. This is done by a supervised maximum likelihood classification. The problem for an automatic approach here is the supervised part of the classification algorithm. Normally this part involves the work of a human operator and requires a lot of experience because the quality of the training areas is a crucial factor for the quality of the classification result. As the digitising of the training areas is time intensive and new training areas have to be digitised for every new data set (because of atmospheric effects, different spectral diffusion depending on the sunlight, different spectral characteristics of vegetation depending on season or soil, etc.), a method is needed to derive the training areas in an automatic way. Having assumed that the number of wrongly collected GIS objects and the number of changes in the real world are substantially less than the number of all GIS objects of the data set, the training areas can be derived automatically from the already existing GIS data. The higher the quality of the training areas the better will be the result of the classification. Therefore, the object geometry is not used as stored in the GIS database - a pre-processing has to be performed first.

After the classification it must be decided which of the GIS objects do not match the remote sensing data. This can be either objects where a change in the landscape has occurred or objects that were not collected correctly. All GIS objects are subdivided into three classes. The first class contains all objects which are detected with a high certainty in the remote sensing data, the second class contains all objects which are detected only partly and the third class contains all objects which cannot be detected at all. The decision to which class an object belongs is made by measuring the percentage of pixels which are classified to the same landuse class as the object itself belongs to. Optionally the form and the homogeneity of the correctly classified pixels are used. Very small or narrow objects are evaluated less strict than normal objects.

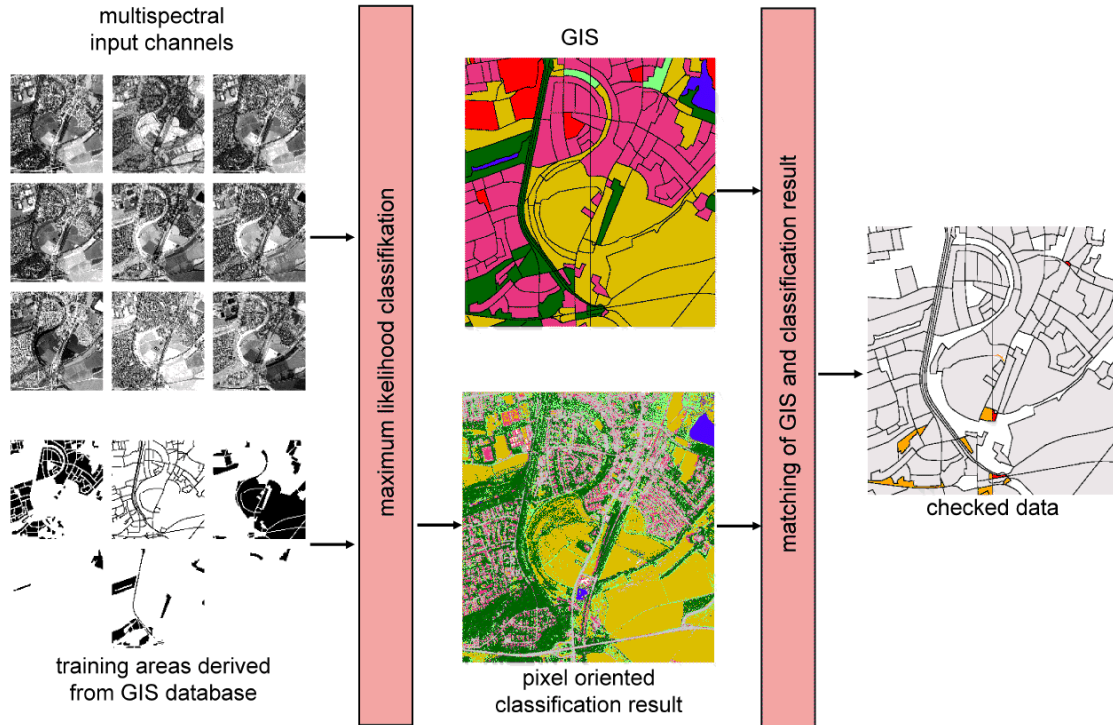

*Fig. 6: The multispectral channels are classified with a supervised maximum likelihood classification and afterwards the classification result is matched with the GIS data.*

The approach is realised in a software package based on UNIX and X-Windows and implemented in such a way that all parameters can be changed interactively by the user and stored as a project. Additionally a visualisation component is available to explore the results interactively on the screen. The software is designed in such a way that there are no limitations regarding the geometric resolution, the size of the images or the definition of the spectral bands. This enables the examination of data from very different sources.

The developed approach was tested with data from different sensors (MOMS-2P, IRS-1C, DPA, scanned analogue rgb and cir orthophotos). The quality of the results depends on three different factors: the geometrical resolution, the radiometrical resolution and the definition of the spectral bands. The required geometrical resolution depends on the scale of the data that have to be updated. For example, for the scale 1:25,000 a geometric resolution of 2 meter is sufficient in order to get interpretable and reliable results. A radiometric resolution of 8 bit is sufficient for the classi-

fication to separate the different land use classes and is provided by most of the existing sensors. More important is the definition of the spectral bands of the sensor. A reliable classification of areas with strong shadow is only possible if a channel in the near infrared is available.

In general it can be said that the higher the amount of information of the input data the better are the classification results. As in many other fields integration is the magic word. A very high information content can be achieved by integrating data with very different characteristics. This can be done for example by the combination of multispectral and laser data. Laser data improve the classification result significantly because they have a complementary behaviour as multispectral data. With laser data the classes greenland and street can be separated very good from the classes forest and settlement because of the different heights of the pixels above the ground whereas in multispectral data the classes greenland and forest can be separated very good from the classes streets and settlement because of the strongly different percentage of chlorophyll.

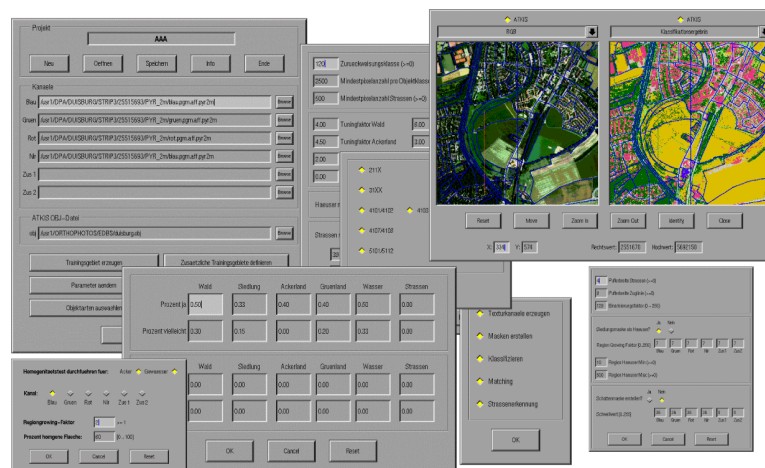
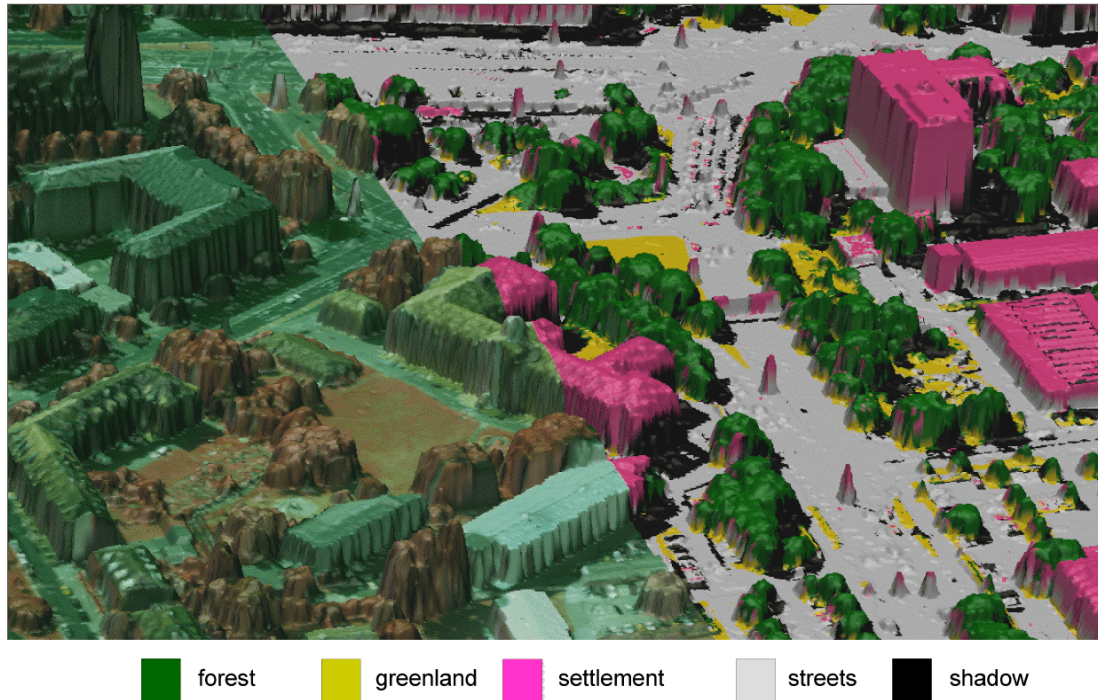

Fig. 7: The software package is developed under Unix and X11 Windows.

The results show that an automatic update of GIS data in scales down to 1:25,000 can be done in an reliable way with data which we are expecting from the new satellite systems. But this is only valid for area objects. For line objects (like streets, railways, etc.) the information content is to low and also a more complex data processing is necessary. The best results can be achieved with the combination of cir images and laser data. With this combination it is also possible to verify objects in larger scales down to 1:2,500 (for example ground plans of buildings) if the images and the laser data are collected in high resolution.



*Fig. 8: Very high quality results can be achieved by the integration of data with different characteristics. The input data (cir data and laser data) can be seen in the left part of the image and the classification result superimposed on the laser data in the right part of the image.*

### **Multimedia GIS Training**

The ifp is designing and developing learning modules which will be used as a supplementation for the lectures GIS I and partly GIS II. All modules are created in XML. The multimedia content which includes vector animation as well as audio and video components is generated with the authoring tool Flash 5 from Macromedia. The system is based on a teaching platform on which the learning modules and the access rights are administrated and the communication systems are implemented. Arc/INFO 8.1 is used as GIS software, ArcSDE 8.1 as middleware for the multi user administration and as an interface to the MYSQL database. The access to the virtual landscape is realized with MapServer ArcIMS 3.1.

The bilingual module *Remote Sensing* is one part of the curriculum unit: *Primary Data Acquisition*. The students should gain insight into different active and passive remote sensing systems. The physical basics of electromagnetic waves are presented with vector animations. Another subject

are satellite systems like Landsat, SPOT, IRS, ERS, IKONOS, Quickbird and RapidEye. Special attention is put to interpretation techniques, integration of remote sensing data in GIS, image processing, applications as well as international sources of data supply. In the exercise part of the module, the students have to search for data sources for a infrastructure project in different countries, document the metadata results and store them in a database. Furthermore the students have to interpret satellite images and digitise landscape elements. The results can be compared and corrected by a tutor.

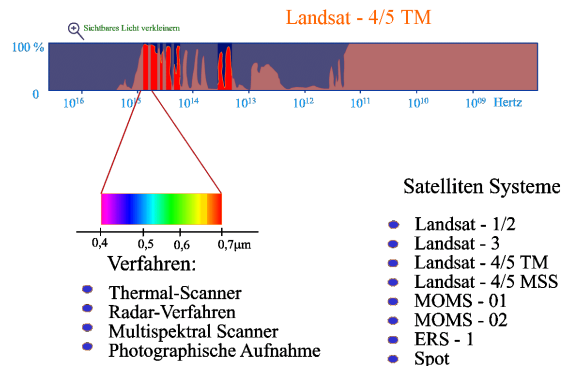

Fig. 9: This is a part of a Flash animation explaining electromagnetic waves

The described *Remote Sensing* module is one of fifteen modules which are part of the lectures GIS I und II. In the forthcoming winter semester 2002/2002 the modules will be used in teaching. At the end of the developing phase in August 2003 there will be a final project evaluation of the whole interdisciplinary learning platform.

## Sensor integration

### Mobile Photogrammetry

In the last years location aware applications or location based services become more and more public to support mobile users, especially in urban environments like car navigation or tourist city information systems. Besides these stand-alone solutions more generic and flexible approaches like the NEXUS project are in their realization phase, where several different interactions between users and real or virtual world objects are supported. All approaches are based on the knowledge of actual position of any user to provide intuitive access to the object related information. This need for permanent location information with sufficient high quality is one crucial task for successful system realization. Especially in urban areas this task is quite demanding since the exclusive use of GPS is non-sufficient mostly due to the well known problems like multipath effects or signal shading in urban canyons resulting in positioning errors raising up to 100m or more. Therefore,

the integrated use of several different sensors supporting each other provides highest flexibility and reliability. One possible integration approach is shown in Figure 10, where DGPS receiver, digital compass, tilt sensor, digital camera and laser distance meter are combined in such a way that besides digital imagery first approximate values for the exterior orientation elements of the camera are delivered. Within this prototype the digital imagery is not only used for visualisation of real objects but for refinement of the exterior orientation of sensors platform, which is almost identical with the users position. Finally, the information from imagery provides a high quality estimation of the aspired positions of the individual users.

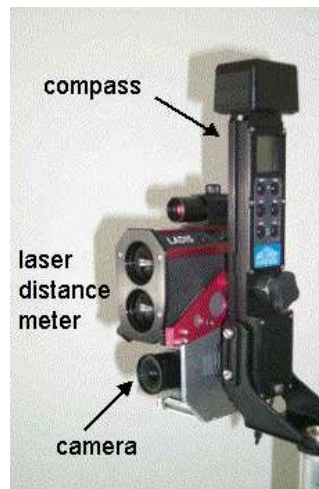

*Fig. 10: Prototype device for mobile photogrammetry*

To realize this positioning functionality, information from the 3D city model, e.g. highly detailed building models, is superimposed with the image itself by using the initial first approximations of exterior orientation elements from the different georeferencing components (see Figure 11). This model to image mapping has to be refined since the quality of directly measured exterior orientation elements does not fulfil highest requirements which are necessary for applications like telepointing functionality or extraction of facade textures from the captured image. One option to improve the mapping accuracy is the refinement of the camera exterior orientation based on spatial resection using 3D coordinates of visible building primitives. Therefore, corresponding points between the image and real object space from 3D models are identified. This measurement is done manually in the moment but future work aims on the automatic matching of corresponding primitives. Figure 12 gives an example of the refined transformation, which is based on the result of the spatial resection process. Currently, the refined transformation is used as reference measurement to evaluate the performance of directly measured exterior orientation. By comparison of the results from both approaches an accuracy of 1-2m (positioning) and 1-3deg (attitude) is verified for this prototype sensor configuration.



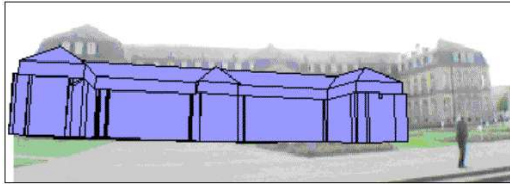

*Fig. 11: Projection based on directly measured exterior orientation from GPS and compass and tilt information*

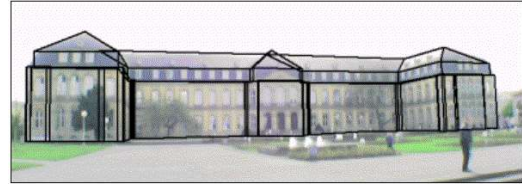

*Fig. 12: Projection after refined orientation from spatial resection*

### Integrated sensor orientation

Within the last years extensive research was done using integrated GPS/inertial systems for the direct georeferencing of airborne sensors for high-end photogrammetric applications. Pushed by the development and practical use of digital sensor systems, originally started with laser scanner systems and followed by imaging multi-line pushbroom scanners, GPS/inertial modules are the central component for the sensor orientation process. Even for standard frame based camera systems, digital or analogue, the use of direct orientation measurements is useful in especially - from a photogrammetric point of view - unfavourable applications like corridor surveys or single model orientation. In the ideal case using direct exterior orientation elements with sufficient accuracy image orientation without any ground control - the everlasting vision of photogrammetrists - should come true.

Several test flights using commercial high-quality GPS/inertial systems (their inertial components are depicted in Figures 13 and 14) have shown that today's accuracy performance of direct georeferencing from medium image scales (1:13000, wide-angle camera) in object space is about 5-20cm (RMS) for the horizontal and 10-25cm (RMS) for the vertical component. Using large scale imagery from lower flying heights above ground results in slightly better object point quality. Additionally, a large image overlap providing a strong block geometry positively influences the point accuracy since multiple image rays can compensate remaining errors in the orientation parameters. Although the obtained quality is quite sufficient for a bulk of photogrammetric applications like orthoimage production this accuracy is still about factor 2-3 worse compared to the accuracy potential of standard AT based on ground control points.

The overall system quality is mainly dependent and limited on the correct overall system calibration, including the orientation sensors plus the imaging component. In several test flights systematic and, moreover, scale dependent offsets in the vertical coordinate of object points were present. Besides the essential boresight alignment calibration the precise overall system calibration is mandatory before using the system for direct georeferencing, otherwise uncompensated systematic errors will affect the system performance significantly and finally prevent to reach the

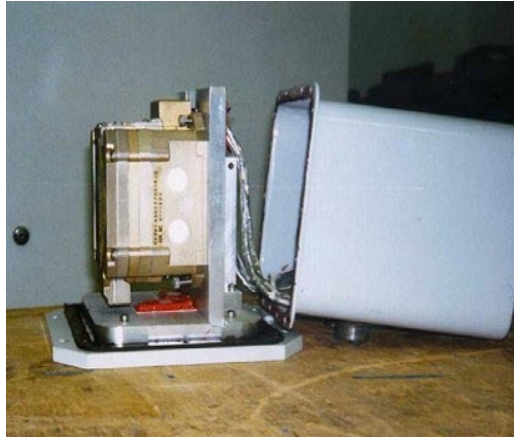

Fig. 13: Inertial measurement unit (IMU) Applanix POS/AV 510 DG



Fig. 14: Inertial measurement unit (IMU) IGI AEROcontrol IId

well known accuracy level from standard AT. Most likely, the overall calibration will be determined within a small calibration block and then used for the subsequent test areas, unfortunately the stability of system calibration over a longer time period and the quality of calibration transfer between calibration site and mission area is not proven yet. In an ideal scenario the calibration should be performed in the mission area directly. Such an in-situ calibration not only results in significant cost savings since no additional effort for calibration flight and data processing is necessary, also the optimal calibration parameters valid for the specific test area could be determined. This was the motivation for the development of an extended GPS/inertial assisted AT process or so-called integrated sensor orientation which was realized in the ifp adjustment software *DGAP*. The software is based on the well known bundle adjustment approach and its fundamental collinearity equation. Besides standard functionalities like camera self-calibration using different parameter sets (orthogonal polynomials or physical relevant calibration models) directly measured GPS/inertial positioning and attitude data are introduced as direct observations in the adjustment process. The software is expanded with additional correction terms to handle systematic errors in the exterior orientation elements from GPS/inertial. In the best case this additional unknowns are used to estimate the inherent boresight-alignment angles to correct the misalignment between sensor coordinate frame and inertial body frame, which is possible even without using ground control for image block configurations. Otherwise, offsets or linear correction terms are introduced to eliminate the influence of systematic positioning or attitude offsets or linear errors for example due to incorrectly determined phase ambiguities or remaining gyro biases. Based on the data from a medium scale test flight (1:10000) the potential of this software is demonstrated. The image block consists of 5 strips, two of them flown twice. Altogether 85 images (60% long and side overlap,

wide-angle camera) were collected during the flight using an analogue aerial camera. High quality GPS/inertial exterior orientation measurements are available. For quality tests the coordinates of 13 well distributed independent object points with a positioning accuracy of 1cm are signalled. These points are used for the estimation of the overall exterior system performance. Figure 15 shows the horizontal and vertical residuals in object space after standard GPS-supported AT using 4 ground control points (GCP) in the corners of the image block. The RMS values from 9 independent check points are about 5cm (horizontal) and 10cm (vertical), which is the accuracy performance being expected for such block configuration. Comparing these results to the results from direct georeferencing without using ground control and without refined system calibration the performance in object point determination is significantly worse. As already mentioned above the accuracy is about factor 2-3 worse compared to traditional AT, resulting in RMS values of 17cm (east), 18cm (north) and 23cm (vertical) for the different coordinate components. These remaining errors from insufficient system calibration are significantly eliminated when using the integrated sensor orientation. Even with the use of one single ground control point only, the final object quality from check point analysis is about 6cm for all three coordinate axes. This potential is similar to the results from traditional AT as shown in Figure 14 which shows the high potential of integrated sensor orientation. Integrated sensor orientation is the only way to fulfil highest accuracy and reliability requirements with minimum number of ground control.

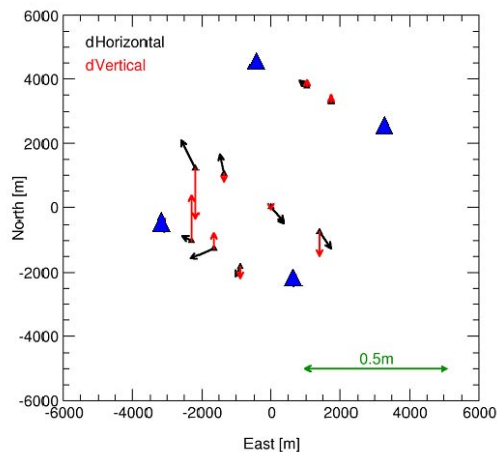

Fig. 15: Residuals after GPS-supported AT with self-calibration based on 4 GCP

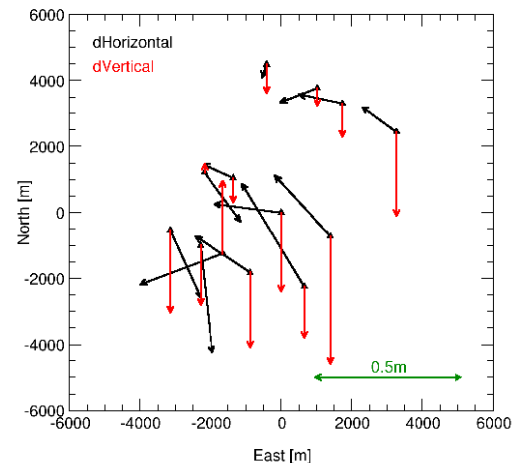
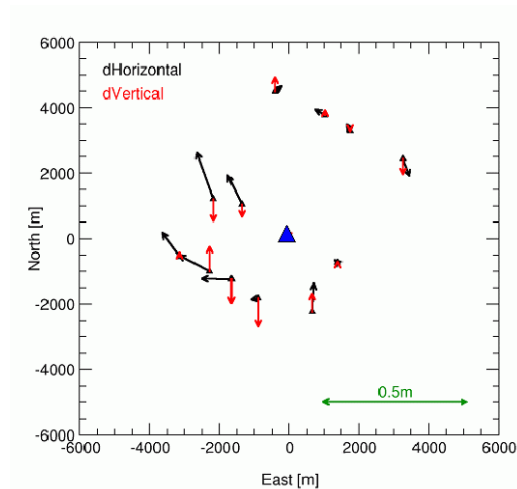

Fig. 16: Residuals after direct georeferencing, with non-optimal system calibration



*Fig. 17: Residuals after integrated sensor orientation with self-calibration using 1 GCP*

## Optical Inspection

### Dense 3D shape acquisition

Photogrammetric shape acquisition systems provide fast and dense surface measurements without the need for physically probing surfaces, thus making them ideally suited for various applications in industrial inspection and reverse engineering. The industrial application of these systems has been one of the main research focuses for the past years and will remain an important topic for the future. With increased availability of low-cost camera systems and projection units, it is now possible to build low-cost scanning systems. This opens new areas of applications for photogrammetric shape acquisition systems, which in the past have been hindered by price considerations.

### Industrial application

In the past few years we have seen a tremendous growth in the number of 2-D and 3-D vision system for inspection and gauging. Their speed, flexibility and accuracy has made optical measurement systems quite popular for many applications in industry. Currently we can observe a trend, mainly at automobile manufacturers, to replace static measurement setups with flexible measurement units using general purpose robots, which perform a series of measurements using a single sensor. This new generation of measurement systems is characterized by certain limitations. Typically they consist of only one single type of sensor, often a laser triangulation sensor.

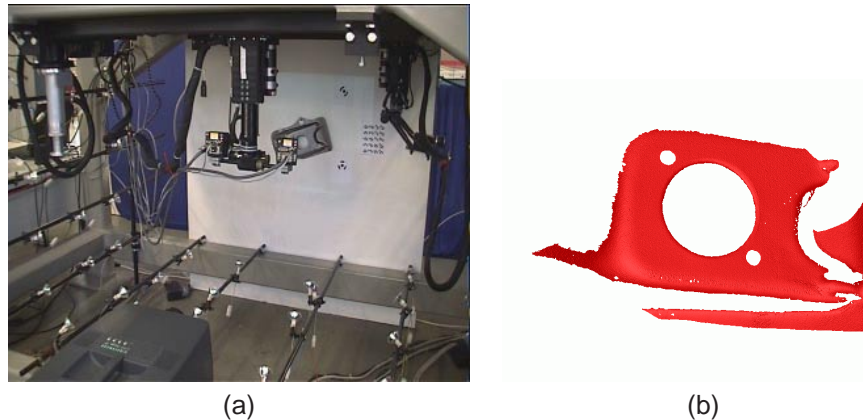
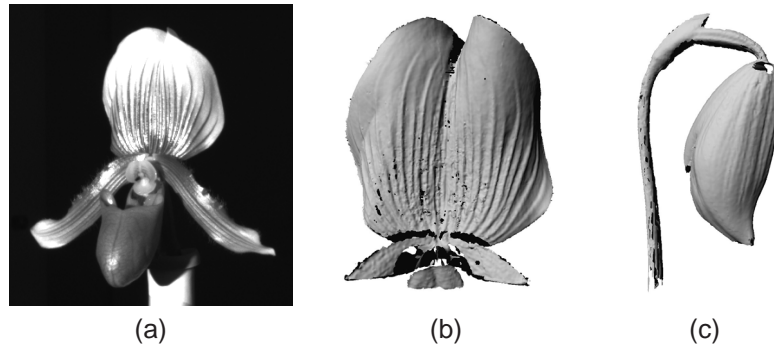

Fig. 18: (a) Multi-Sensor measurement unit; (b) three-dimensional data-set of a car part, as it has been recovered by the measurement unit to the left.

Usually the sensor can perform only a single measurement task, such as edge measurement. If several of these systems are combined to form a larger set up, they perform their task independently and without interaction. All motions are pre-programmed, usually they have been taught by hand. The system performs repetitive measurements of a single class of objects.

It is our and our partners vision to design a system which is to overcome these limitations. We aim at implementing a highly flexible measurement system using several different types of sensors. Flexibility to us has two meanings, for one we wish to be flexible in what we measure i.e. the kind of objects we aim at and second in how we do it i.e. what sensors we use. Our system is not designed for a single class of objects but for a large variety of objects varying in size, shape and material. Using different types of sensors we exploit the possibility of combining sensors and illumination devices such that we achieve the optimal setup for the specific task. The single steps of a measurement sequence shall not be chosen by hand but are to be computed automatically on the basis of a given CAD model and the ability to actively explore the scene.

We give the example of the integration of a stripe-projection unit into a multi-sensor measurement unit (see figure 18(a)). The machine has been designed for the automatic measurement of industrial parts. It carries up to three sensors. One of them is a Stereo camera with a base length of 300 mm. This stereo camera has been combined with a LCD projector to form a 3D-sensor capable of dense surface measurements. Using the machines robotic hands the camera can be positioned automatically to achieve optimal configuration towards the object. In this example the object has been a sheet metal part of car body approximately 30 cm in length. The system captured about one hundred thousand points on the objects surface in only a few seconds (see figure 18(b)).



*Fig. 19: (a) Camera view of the orchid; (b) CAD model of the single top leaf of the blossom; (c) CAD model of closed blossom.*

#### Non-industrial application

The following is a short description of a project carried out in cooperation with the architect M. Balz, who approached us with the request for the acquisition of the 3D shape of an orchid blossom. Using our standard scanning set-up, consisting of a digital projection unit and a digital video camera, we took 12 shots of the blossom on a rotation table in 30 degree increments. The separate shots were aligned and fused to form a single model of the blossom. Over a million points were scanned. The complete model consists of more than one hundred thousand points. Views of the blossom and the derived CAD model are shown in figure 19.

#### Online pose estimation for robotics

While industrial robots typically can achieve a repeatability of 0.1mm or less, their absolute accuracy can be in the range of only 1mm or worse. Many new applications in robotics, including flexible optical measurement, require improved absolute accuracy. Photogrammetry has been used for several years to perform off-line calibration in order to increase accuracy. However when operating a robot under shop-floor conditions the accuracy is expected to decrease again over time. Clearly an on-line pose correction is desirable. We present a system for the on-line pose measurement based on photogrammetry. We have implemented a system where a high-resolution digital camera is mounted onto the robots end-effector. The camera observes coded targets placed in the working cell. The position of the retro-reflective targets has been established beforehand photogrammetrically using a hand-held high-resolution digital camera. From the known coordinates of the observed targets the exact location of the camera mounted onto the robot can be computed via resection.

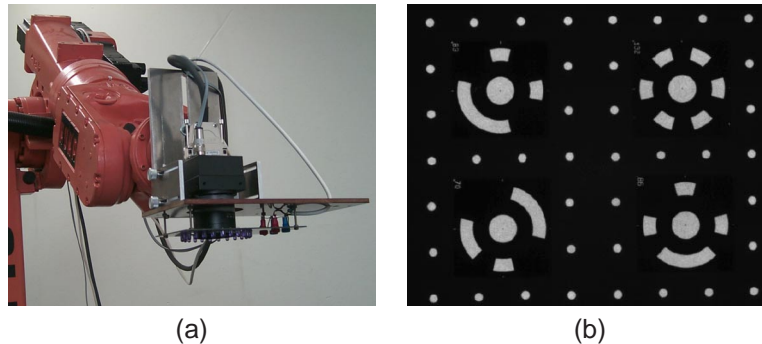

Fig. 20: (a) Camera on the robot observing fixed targets in 3D space; (b) Camera view of the coded targets with additional uncoded targets.

## Hardware

The optical sensor we are using is a Basler A113 camera, with a Sony CCD chip, which has a resolution of  $1300 \times 1030$  pixels. The camera provides a digital output according to IEEE standard RS644. A frame-grabber is integrated into a standard PC. The digital camera system is superior to an analog camera system since it does not exhibit line jitter problems thus enabling more precise measurements. Schneider-Kreuznach lenses with 12mm focal length are mounted onto the camera.

To maximize the signal intensity we use retro-reflective targets and a ring light on the camera. To minimize the effects of external light sources we use near-infrared LEDs as light source and a filter on the lens. (see figure 20, left)

The control points are fixed onto a plane, also used as a calibration plate. We use coded targets to achieve automated identification of the targets. The circular center of the target is used for sub-pixel precise measurement of the targets position. A circular code surrounding the center carries a binary representation of the unique identifier. (see figure 20, right)

The set-up for our experiments consists of a Kuka KR15 robot. It is a six axis robot with a maximum payload of 15kg at maximum range of 1570mm. The robot is specified with a repeatability of  $\pm 0.1$ mm. The absolute accuracy is not specified.

## Image processing

Image processing is performed on a standard PC. The images are first binarized using an optimal thresholding algorithm. Then a consistent component labeling is performed to find targets. We discriminate the circular centers from all other 'blobs' by size and a simple shape-test. Since the targets can be smaller than 10 pixels in diameter we do not perform ellipse fitting. The center of the target is computed as the weighted centroid.

standard deviations	simulation		test-run
image measurement	$\frac{1}{5}$ pixel	$\frac{1}{10}$ pixel	...
resection in x	0.06 mm	0.03 mm	0.2 mm
resection in y	0.06 mm	0.03 mm	0.2 mm
resection in z	0.02 mm	0.009 mm	0.06 mm

Table 1: Standard deviations of resection.

In addition the elliptic axes and the pose angle are computed. The center, the axes and the angle are used to determine the code ring. The code ring is read with six-times oversampling. The acyclic redundant code provides unique identifiers for up to 352 targets.

In addition to the coded target much smaller uncoded targets were added to the test field. After the closed-form resection has been computed using the coded targets, the approximate position of these targets can be projected onto the image since their three-dimensional location is known from calibration. Thus these additional targets can be easily identified through their position.

## Results

The sensor delivers a frame rate of about 12 frames per second. The implemented system is capable to process a single image in 420 ms. A typical image will contain about 30 coded and about 200 uncoded targets. This gives us a processing speed of 500 targets per second including all image processing steps and the resection. The standard deviations obtained in a test run are given in table ??.

## References 2001

- Balz, M., Gühring, J.: Botanic Shell Structures, IASS 2001, Nagoya, Japan.
- Böhm, Jan: Erfassung und Interpretation von dichten Oberflächendaten, in: Band 10 DGPF-Jahrestagung, Konstanz, pp. 302 - 308.
- Böhm, J., Gühring, J. and Brenner, C.: Implementation and calibration of a multi sensor measuring system, in: 'Photonics West, Videometrics VII', Vol. 4309, SPIE, San Jose, USA, pp. 154 - 161.
- Böhm, J., Hefele J.: Towards On-Line Pose Measurement for Robots, in: Pattern Recognition: 23rd DAGM Symposium Munich, Germany, September 2001, Lecture Notes in Computer Science 2191, Springer, pp. 298 - 304.
- Brenner, C.: City Models - Automation in Research and Practice, in: D. Fritsch and R. Spiller, eds, 'Photogrammetric Week '01', Herbert Wichmann Verlag, Heidelberg, pp. 149-158.



- Brenner, C. and Haala, N.: Automated Reconstruction of 3D City Models. In Abdelguerfi, M. (ed), 3D Synthetic Environment Reconstruction. Kluwer Academic Publishers, pp. 75-101.
- Brenner, C., Haala, N. and Fritsch, D.: Towards fully automated 3D city model generation. In Automatic Extraction of Man-Made Objects from Aerial and Space Images III, pp. 47 - 56.
- Cramer, Michael: On the use of direct georeferencing in airborne photogrammetry, in Proceedings 3rd. International Symposium on Mobile Mapping Technology, Januar 2001, Cairo, digital publication on CD, 13 pages.
- Cramer, Michael: Performance of GPS/Inertial Solutions in Photogrammetry, in: D. Fritsch and R. Spiller, eds, 'Photogrammetric Week '01', Herbert Wichmann Verlag, Heidelberg, pp. 49-62.
- Cramer, Michael: Performance of IGI AEROcontrol-III GPS/inertial system. Final report on AERO-control airborne test flight Vaihingen/Enz (June 2000), Institute for Photogrammetry (ifp), University of Stuttgart, Germany, 16 pages.
- Cramer, Michael: Genauigkeitsuntersuchungen zur GPS/INS-Integration in der Aerophotogrammetrie. Dissertation, Deutsche Geodätische Kommission, Reihe C, Heft Nr. 537, 120 Seiten, München.
- Cramer, M. and Stallmann, D.: On the use of GPS/inertial exterior orientation parameters in airborne photogrammetry Proceedings of the OEEPE workshop on Integrated sensor orientation, Hannover, Germany, pp. 32-44 (CD-ROM edition).
- Fritsch, D., Klinec, D., Volz, S.: NEXUS - positioning and data management concepts for location-aware applications. Computers, Environment and Urban Systems, 25, pp. 279-291.
- Fritsch, D., Spiller, R.: Photogrammetric Week '01. Wichmann, Heidelberg, 341 p.
- Fritsch, D.: Electronic Business and Mobile Photogrammetry: Visions for the Future, in: D. Fritsch and R. Spiller, eds, 'Photogrammetric Week '01', Herbert Wichmann Verlag, Heidelberg, pp. 23-34.
- Fritsch, D.: Geo-Informationssysteme im Spannungsfeld von Mobilität und Gesellschaft. Geo-Informationssysteme (GIS), GeoBIT/GIS 9/2001, pp. 9-12.
- Gühring, J.: Dense 3-D surface acquisition by structured light using off-the-shelf components, in: 'Photonics West, Videometrics VII', Vol. 4309, SPIE, San Jose, USA, pp. 220 - 231.
- Gühring, J.: Reliable 3D surface acquisition, registration and validation using statistical error models, 3DIM 2001, Quebec City (Canada), pp. 224-231.
- Gühring, J., Böhm, J., Fritsch, D.: Recent Advances in the Implementation of a Multi-Sensor Measuring System, 5th Conference on Optical 3-D Measurement, Wien, pp. 226 - 233.
- Haala, N.: Anwendungspotential virtueller Stadtmodelle in Publikationen der Deutschen Gesellschaft für Photogrammetrie und Fernerkundung Band 9 , pp. 98-105.

- Haala, N.: Automated image orientation in a location aware environment, in: D. Fritsch and R. Spiller, eds, 'Photogrammetric Week '01', Herbert Wichmann Verlag, Heidelberg, pp. 255-262.
- Hefele, Jürgen: On-Line Pose Messsystem für Roboter, in 21. Wissenschaftlich-Technische Jahrestagung der DGPF, Konstanz, 2001 Seite 311-316.
- Hild, H.: Automatic Image-To-Map-Registration of Remote Sensing Data, in: D. Fritsch and R. Spiller, eds, 'Photogrammetric Week '01', Herbert Wichmann Verlag, Heidelberg, pp. 13-23.
- Klinec, D. and Leonhardi, A.: Positioning and Location Services for Indoor Areas in NEXUS, International Symposium on Indoor Navigation - INDOORNAV 2001, Munich, Germany, pp. 101-112.
- Klinec, D. and Fritsch, D.: Acquisition of Position Information for Location Aware Applications using Multi Sensors and Mobile Photogrammetry, Proceedings of ION01, Salt Lake City, USA.
- Nicklas, D., Großmann, M., Schwarz, T., Volz, S., Mitschang, B.: A Model-Based, Open Architecture for Mobile, Spatially Aware Applications. Proceedings of the Symposium on Spatial and Temporal Databases, Los Angeles.
- Nicklas, D., Großman, M., Schwarz, T., Volz, S.: Architecture and Data Model of Nexus. In: GIS - Geo-Informationssysteme, 9/2001, Wichmann Verlag, Heidelberg, pp. 20-24.
- Volz, S.: Information Management for Location Aware Applications, in: D. Fritsch and R. Spiller, eds, 'Photogrammetric Week '01', Herbert Wichmann Verlag, Heidelberg, pp. 5-12.

## Diploma Theses

- Christoph Dold: Filtering of Laser Altimetry Data - Conventional Methods and new Adaptive Approach Realised with a Graphic User Interface, Supervisor: Dr.-Ing. Norbert Haala.
- Jan-Martin Bofinger: Analyse und Implementierung eines Verfahrens zur Referenzierung geographischer Objekte, Supervisor: Dipl.-Tech. Math. Alexander Bracht (DaimlerChrysler AG), Dipl.-Ing. Steffen Volz, Dr.-Ing. Volker Walter.
- Jan Stinka (2001): Bereitstellung von raumbezogenen Daten in Oracle8i Spatial, Optimierung der Indizierung und des Datenbankdesign, Supervisor: Dipl. Ing. Sabine Knapp, Dr. Ing. Volker Walter.
- Timo Balz (2001): Entwurf und Entwicklung von Bildverarbeitungsverfahren zur Kartenaktualisierung auf Basis von Satellitenbildern, Supervisor: Prof. Dr. R. Hahn, Dr.-Ing. Norbert Haala.

## Study Theses

Jan Stinka: Animationen und Visualisierung eines 3D-Gebäudemodells, Supervisor: Dipl.-Ing. Thomas Schürle.

Richard Link: DGM - Generierung aus Stereobildern - Interaktive Editierung am Beispiel des Programmpaketes Virtuoso, Supervisor: Michael Cramer.

Steffen Firchau: Telepointing - Positionsbestimmung und Sichtbarkeitsanalyse durch Kombination terrestrischer Bilder mit 3D-Stadtmodellen, Supervisor: Darko Klinec.

## Doctoral Theses Supervisor Dieter Fritsch

Michael Glemser: Zur Berücksichtigung der geometrischen Objektunsicherheit in der Geoinformatik, Deutsche Geodätische Kommission (DGK), Reihe C, Nr. 539 (in print).

Holger Schade: Neigungsbestimmung mit GPS für die Photogrammetrie.

## Activities in National and International Organizations

Dieter Fritsch

President of the University of Stuttgart

Editor-in-Chief of the journal 'Geo-Informationssysteme GIS'

## Education - Lecture/Practice/Training/Seminar

Adjustment theory and Statistical Inference I,II,III (Fritsch)	5/3/0/0
Aerotriangulation and Stereo Plotting (Cramer)	1/1/0/0
Cartography (Haala)	1/1/0/0
Civil Law (Schwantag)	2/1/0/0
Close Range Photogrammetry (Böhm)	1/1/0/0
Digital Elevation Models (Haala, English)	1/1/0/0
Digital Image Processing (Haala)	1/1/0/0
Geodetic Seminar I, II (Fritsch, Grafarend, Keller, Kleusberg, Möhlenbrink)	0/0/0/4
Geographic Information Systems I,II,III (Fritsch, Walter)	5/1/0/0
Geographic Information Systems for Infrastructure Planning (Walter)	2/1/0/0
Geographic Information Systems for Environmental Monitoring (Walter)	2/1/0/0
Geometry and Graphical Representation (Cramer)	1/1/0/0
Introduction to Photogrammetry (Cramer)	1/1/0/0
Image Processing and Pattern Recognition I,II (Haala)	4/1/0/0
Image Acquisition and Mono Plotting (Cramer)	2/1/0/0
Practical Training in GIS (Bofinger, Hefele, Kada, Volz, Weippert)	0/0/4/0
Practical Training in Digital Image Processing (Haala)	0/0/4/0

---

Programming in C (Böhm, Kada)	1/1/0/0
Signal Processing for Geodesists (Fritsch, Böhm)	2/1/0/0
Software Development (Fritsch, Grafarend, Keller, Kleusberg, Möhlenbrink)	0/0/4/0
Urban Planning (Schäfer)	2/1/0/0

