

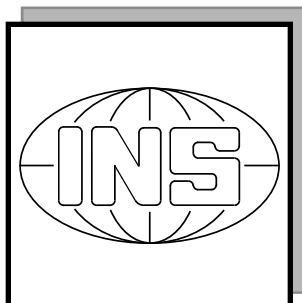

# The Department of Geodesy

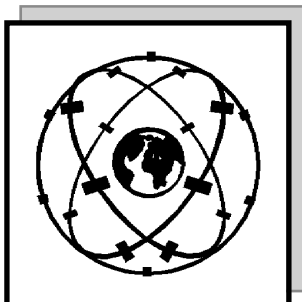

Stuttgart University  
2000



**editing and layout:**

volker walter, friedhelm krumm, ulrich hangleiter, wolfgang schöller

## Preface

Dear friends of The Department of Geodesy of the University of Stuttgart, we are pleased to offer you our 2000 report. This information service introduced in 1993 has found interest within the geodetic community all over the world, thank you very much for cooperating with us. The Stuttgart School still is and hopefully will be active in the future in the fields of satellite geodesy, mathematical geodesy, navigation, land surveying and engineering surveys, telematics, photogrammetry, remote sensing and geographic information systems.

One of the highlights in 2000 was the election (March 1st, 2000) of Dieter Fritsch to serve as Vice Chancellor (Rector) of the University of Stuttgart for a six year term. He started at October 1st, 2000 and will be in office until Sept 30th, 2006. This position offers him the opportunity to promote also the discipline of geodesy and geoinformatics, to potential students at schools, to politicians, to decision makers in industry and other people in society. Thus, we as a small but well-educating department at Stuttgart University feel honored and are proud for this personal decision.

We are still concerned with the number of incoming students. Since the last four or five years this number is incredibly low. Therefore we started an initiative to visit Gymnasiums around Stuttgart to advertise the pros of a high tech curriculum. We hope that the 'valley' of less incoming students is overcome very soon. We all feel, that the attractive projects presented in this brief overview will help us to attract more students in near future.

This report is also WEB accessible to allow for colored figures and further services: download of papers, videos, lecture notes, etc. Please visit our website:

<http://www.ifp.uni-stuttgart.de/education/jahresberichte/injahresber.html>

Dieter Fritsch  
Alfred Kleusberg

Erik W. Grafarend  
Wolfgang Möhlenbrink

Wolfgang Keller





## Institute for Applications of Geodesy to Engineering

Geschwister-Scholl-Str. 24/D, D-70174 Stuttgart,  
Tel.: +49 711 121 4041, Fax: +49 711 121 4044  
e-mail: Sekretariat@iagb.uni-stuttgart.de or  
firstname.secondname@iagb.uni-stuttgart.de  
url: <http://www.uni-stuttgart.de/iagb/iagb.html>

### Head of Institute

Prof. Dr.-Ing. Wolfgang Möhlenbrink  
Dipl.-Ing. Ulrich Hangleiter, Akad. Direktor

### Secretary

Christel Schüler

### Emeritus

Prof. Dr.-Ing. Dr.sc.techn.h.c. Dr.h.c. Klaus Linkwitz

### Scientific Staff

Dipl.-Ing. Roland Bettermann	traffic information, digital maps
Dipl.-Ing. Renate Czommer	map matching
Dipl.-Ing. Matthias Dünisch	geodetic measurement techniques
Dipl.-Ing. Andreas Gläser	integrated sensors for vehicle navigation
Dipl.-Ing. Andreas Eichhorn	GPS-INS-integration
Dipl.-Ing. Carsten Hatger	digital cartographie
Dr.-Ing. Heiner Kuhlmann	surveying engineering, deformation analysis
Dipl.-Ing. Martin Stark	information and transportation chains
Dipl.-Ing. Thomas Wiltschko	traffic information

### Technical Staff

Niklaus Enz  
Martin Knihs  
Doris Reichert

## General View

The institute's main tasks in education and research traditionally reflect on geodesy, geodetic measurement techniques, engineering geodesy, data processing and traffic information technologies. The institute's daily work is characterised by intensive correlation and co-operation with other engineering disciplines, especially with civil engineering, traffic engineering and construction management. Co-operations exist with other university institutes as well as with the construction and automobile industry and various traffic services.

The education of geodesists was characterised by the perfection of existing lectures and practices. Not only is the institute responsible for different courses within the curricula of Geodesy and Georelated Computer Science but also for the education in surveying of architects and civil engineers. A special lecture in English is held within the curricula Infrastructure Planning. The institute's current research in the fields of geodetic measurement techniques and traffic information techniques is reflected in most lectures. This is also represented in various case studies and diploma theses, often realised in co-operation with industry and public administration.

The institute's current research and development work focuses on the following:

- ▷ geodetic measurement techniques
- ▷ traffic information techniques
- ▷ positioning and guidance in vehicle navigation
- ▷ formfinding of lightweight structures.

In the main field of traffic information techniques the institute is engaged in various scientific projects with the aim to guarantee and improve mobility. The fields of geodetic measurement techniques and vehicle navigation get their impulses from industrial projects.

## Research Work

The institute's current research work can be summarized by the main topic 'Positioning and controlling moving objects in the digitally described 3D-space'. This research work comprises the following activities:

### Geodetic Measurement Techniques

This working area comprises design, development and application of multi-sensor-measurement and data processing of static and dynamic information in civil engineering and surveying. Main interest is laid on the integrated application of different sensors for the determination of building deformations and vehicle navigation.

## Measuring and Guidance Concepts for High Speed Railway Tracks

The construction method „Feste Fahrbahn“, the preferred method for producing high speed railway tracks, requires high standards of reliable geometrical accuracy. This has to be provided at any time by the engineering geodesist involved in the construction process. A new measuring and analysing concept by tacheometry has been developed and put into practice by the institute.

With regard to the measuring process, the calibration of the tacheometer system, the refraction and the stability of the observation net have to comply with the highest standards. A special centering device (fig. 1) and the design of the observation net (fig. 2) were developed, that also provide considerable advantages regarding economy and accuracy.



*Fig. 1: Special force entering equipment*

By means of a measuring vehicle (fig. 3), equipped with a lateral inclination device and gauge measuring device as well as a high precision tracking tacheometer as alignment sensor, the rail can be adjusted to a relative accuracy of  $\sigma_{\Delta, 5m} = 0.6\text{mm}$  (standard deviation). In order to control the measurement, to calculate and indicate the measurement deviations, and to document, as a proof, the adjustment of the rail, a special software was developed and implemented.





## Sensor Integration for Car Navigation

In preparation of the telematic traffic service, a project for the navigation of rail vehicles by means of different sensors was developed in cooperation with a local traffic company. The sensors used were mainly gyros and speed signals. The use of GPS or DGPS is limited due to the inner city location. The circuit diagram of the sensor integration is shown in fig. 4. For the analysis the railway curvatures were derived from the measured data and compared to the curvature function of the track. The vehicle's location is then determined by its position related to the railway. These methods - known as Map-matching - were thoroughly investigated and successfully applied and achieved an average deviation of 0,5m.

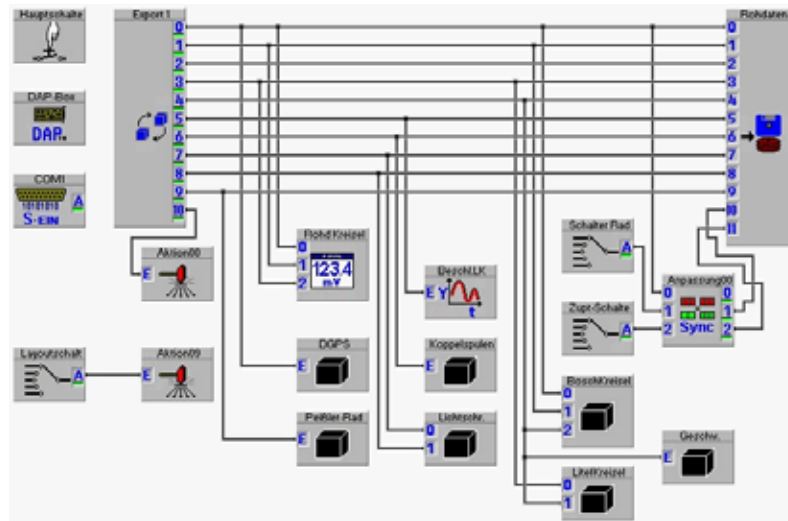

Fig. 4: Multiple sensor integration

## Methodical Development of Deformation Models

The description of the transfer function of an object relating to its external influences (i.e. temperature) is a fundamental task within the deformation analysis. By solving this problem, it is possible to predict relevant object reactions considering deterministic correcting variables. Thus critical system states can be simulated.

In case of a quantifiable physical structure, the time domain transfer function can be formulated by differential equations („White-Box-Model“). With this dynamic modelling method, the system capacity to store and deliver energy with a time delay can be taken into consideration. Consequently, the system behaviour under dynamic loads, respectively the transition between static load states can be described.

In this context, second order differential equations are combined with observations to a dynamic Kalman filter. The material parameters included in the system equations, defined as priori unknown, can be estimated by the adaptive extension of the state vector with a physical partition. Therefore, the adaptation of the system model to the observations can be reached by parametrical identification.

A practical realisation is effected by the identification of oscillating systems. It has been shown that convergent solutions are possible, whereby only few oscillations of the system are required for the identification phase.

## Traffic Information Technology

Within the area of traffic telematics the institute is involved in nearly all the traditional fields of geodetic work, such as digital road maps (virtual traffic surroundings), and positioning of static and dynamic objects. The use of digital road maps for location determination by map matching techniques was the topic of a dissertation, thus emphasising this focus at the institute.

## Autonomous Rail Vehicle Navigation

In co-operation with the Stuttgart Public Transport Company SSB and the Institute of Railway and Traffic the capability of an autonomous navigation component based on map matching techniques for rail vehicles was proved. A further increase in navigation accuracy could be reached by the use of teach-in-formulation. Due to the estimated reliability of the system, it can be presumed that it can also be used for safety-relevant functions.



Fig. 5: Railway positioning

## Safety Increasing Telematic Systems

It was determined through investigations concerning traffic and accidents in urban areas that a considerable potential regarding safety increase of assistant systems for drivers in intersections exists. Through intelligent coupling of vehicle techniques and infrastructure this potential can be satisfied.

Within an industry-backed project a driver assistance system prototype was developed that informed the driver of the valid priority in intersection situations. The information medium, respectively the information platform used, was a commercial navigation system. In an acceptance investigation the driver assistance system was tested with regard to its utility as a safety-increasing assistance system for road traffic.

## Digital GIS-Supported Accident Card

For analysing accidents in urban areas detailed investigations were carried out in a part of Stuttgart. For this purpose a GIS-system was used, in which all traffic-accident relevant data was included. All aspects concerning data basis, data modelling, and geo-references of the accidents locations documented by the police were processed on the basis of a digital road map. In addition to a location-independent analysis, a situation-based analysis of the traffic accidents was effected in a geo-information system by formulating standardised traffic situations.

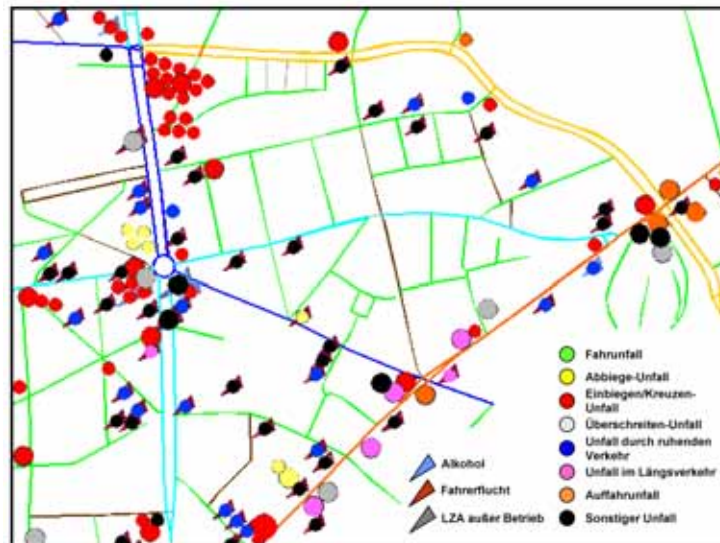

Fig. 6: Digital accident monitoring

## Information Chain of Traffic Information Services

Within the Mobilistproject (mobility in the urban area of Stuttgart) and in close co-operation with other institutes, an evaluation catalogue for routing and mobility services was elaborated in the form of scientific accompanying research. Hereby, especially information processes of service companies, where several transportation systems are put together within an intermodal chain, were analysed. For this purpose the institute has developed a strategy to analyse these information processes as overlapping as possible for all service developments.

This overlapping analysis is the basis of a homogeneous estimation regarding information requirements and costs of information processes to estimate the risk of market introduction of new mobility services. For this special purpose an investigation concerning the availability and cost of digital geo-data was carried out.

Analysis of dynamic driving partnerships: The project „M21“ tests the effects of traffic diminishing mobility services especially with regard to traffic jams due to rush hours on roads and railways. One of these services is the Dynamic Driving Service „FahrPLUS“ developed by DaimlerChrysler AG which calculates and composes driving partnerships for the daily travel to work and back home. In order to analyse the spatial distribution and the different types of driving partnerships, the institute investigated all groups, thus classifying four different groups of driving partnerships.

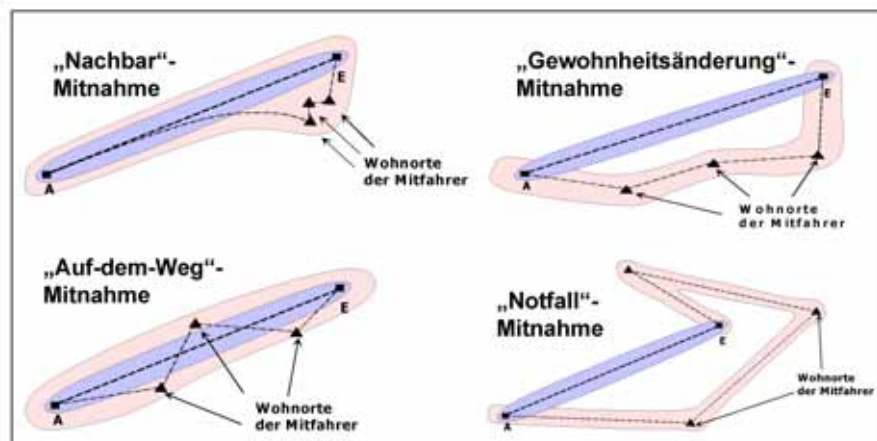

Fig. 7: Nodes of driving partnerships

## Modelling of Intermodal Traffic Data (Project VVU)

Within the project „Virtual Traffic Region Ulm (VVU)“ a data model was created that can be used as a basis for various traffic simulation tools. It project consists of the below mentioned components worked out in cooperation with other traffic institutes.

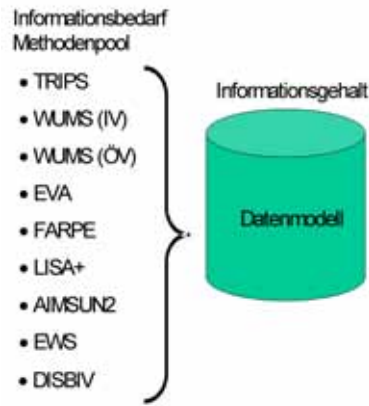

Fig. 8: Data information

*Data Pool:* The virtual traffic region is based on a data pool offering the possibility to image realistically and in time traffic activities in connection with the traffic models. This data base contains methods for modelling public and individual traffic microscopically and macroscopically. The development of a semantic data model for the applications of the method pool also considers, beyond the actual requirements, the necessity of some method extensions. The known models of geo-data and traffic system were adapted as far as possible. In ongoing works, the refinement of the data model, for example in individual traffic for intersections (simulation of light signal devices) or in the public traffic to carry out calculations of route-related capacity are an important task.

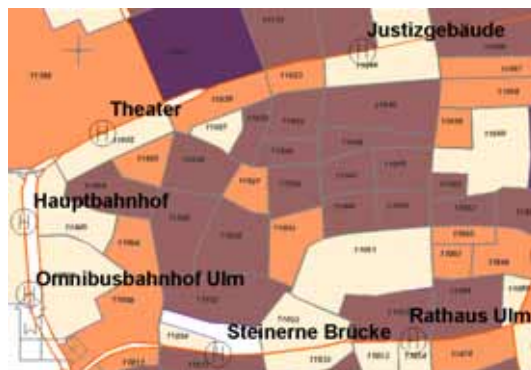

Fig. 9: Visualisation of Geo-referenced Data

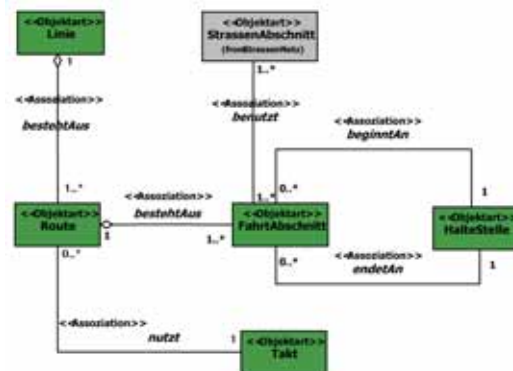

Fig. 10: Extract of the VVU data model (UML-notation)

*Method Pool:* Besides the central data pool, the method pool, which provides standard methods as well as specific application programs, is the core of the virtual traffic region. In order to combine the methods between each other as well as the methods with the detailed data pool in the best possible way, modifications - as a rule adaptations of the interfaces - are necessary.

As a comprising and direct development of the methods could not be effected within the given frame, an analysis of the different model types was elaborated within a literature study. A detailed description of the models existing at the institutes involved and a deficit analysis delivered disposition points for model extensions.

*Prototypical data pool:* As a pilot application a data set for the Ulm region was prepared containing the street net and the public traffic net. As a basis for traffic forecasting and traffic distribution accurate statistic data was collected and geo-referenced. Using these data, model extensions can be tested in practice. Of importance is that the possible advantages of such an accurate definition can be verified and that the models can be adapted to the real data.

The transformation of the theoretical information requirements within the pilot application (*project*) showed the requirements concerning data collection and data preparation. The available data sources have been stated and their advantages and disadvantages have been described.

## **Activities of Professor K. Linkwitz**

### **Formfinding of Lightweight Structures**

The two-hour-lectures „Analytic Formfinding of Lightweight Structures“ for students of civil engineering, architecture and geodesy was successfully held again. The appertaining practical computer exercises have been performed on windows-NT-computers of the CIP-pool of the department of civil engineering (WAREM). As part of the exercises the students did also interdisciplinary project works in some institutes of civil engineering and architecture.

### **Further lecture of K.Linkwitz**

As part of the obligatory course „Engineering Geometry and Design“ given to civil engineers in their first semester by the Institute of Construction and Design II, some lectures on the subject „Typical examples of computer-aided geometric design“ were held.

## **List of Publications 2000**

Czommer, R.: Fahrzeugortung mit Map-Matching-Technologien. Ingenieurvermessung 2000, TU München, 13.-17. März 2000.

Dünisch, M.; Kuhlmann, H.; Möhlenbrink, W.: „Baubegleitendes Festpunktfeld bei der Einrichtung und Kontrolle der Festen Fahrbahn“, Allgemeine Vermessungsnachrichten, Heft 10, 2000.

- Kuhlmann, H.; Dünisch, M.: „Geodätisches Meßkonzept für den Einbau und die Kontrolle der Festen Fahrbahn“. VDV-Schriftenreihe Gleisbau 2000 - Planung und Vermessung, Verlag Chmielorz, Wiesbaden 2000, im Druck.
- Möhlenbrink, W.: Effiziente Infrastrukturstützung durch Leitsysteme. DVWG-Schriftenreihe Nr. 226, Köln 2000.
- Möhlenbrink, W.: Informationsdienste im Verkehr und Verkehrsumfeld. Ingenieurvermessung 2000, TU München, 13.-17. März 2000.
- Linkwitz, K., Schwarz, W.: Geodätisch-photogrammetrische Überwachung von Hängen, Böschungen und Stützmauern 6. neubearbeitete Auflage 2000, Verlag Ernst + Sohn.
- Linkwitz, K.: About the Impact of Structural Engineering to Architecture, Workshop KTH Konstruktionslära Arkitektur / Universität Stockholm, 3.-6.5.2000.
- Linkwitz, K.: Numerical Computation and Principles of Mechanics: C.F. GAUSS, the Great Mathematician and his Ideas about Figures and Formulas; IASS Symposium Computational Mechanics, Chania, 3.-9.6.2000.
- Linkwitz, K.: Examples of Geometrical Reverse Engineering: Designing from Models and/or under Geometrical Constraints; IASS Structural Morphology Group, Delft, 15.- 20.8.2000.
- Linkwitz, K.: About Basic Principles of Form Finding by the Method of Direct Approach, Harvard School of Design and Architecture, Cambridge/Mass., 25.-31.10.2000.
- Welsch, W.; Heunecke, O.; Kuhlmann, H.: „Auswertung geodätischer Überwachungsmessungen. Grundlagen, Methoden, Modelle“. Ein Band der Reihe: Möser, Müller, Schlemmer, Werner (Hrsg.): Handbuch Ingenieurgeodäsie, H. Wichmann Verlag, Heidelberg 2000.

## Doctoral Theses

- Rainer Petzoldt: Realisierung und Anwendung eines Multi-Sensor-Systems zur Bestimmung von kinematischen Bauwerksverformungen

## Diploma Theses

- Krehl, Tobias: Aufbereitung und Auswertung von Deformationsmessungen an der Brücke über das Nesenbachtal
- Labahn, Romy: Entwurf eines Kalman-Filters zur Integration von GDPG und Radsensoren
- Raitinger, Kerstin: Konzeption und Entwicklung einer digitalen Karte für die Rübenlogistik
- Scholz, Sylvia: Entwicklung eines Konzepts zur kinematischen Vermessung von Abständen und Überhöhungen von Nachbargleisen
- Schumann, Jens: Einsatz von standardisierten Analyseverfahren zur Beurteilung der Informationsqualität geodätischer Messungen
- Sofka, Werner: Baubetriebliche und vermessungstechnische Aspekte bei der Herstellung von Verkehrswegen mittels drahtloser Steuerung

## National and International Activities in Scientific and Professional Organisations

Wolfgang Möhlenbrink:

- Member of Deutsche Geodätische Kommission (DGK)
- Member of Deutscher Verein für Vermessungswesen (DVW)
- Member of Deutsche Gesellschaft für Ortung und Navigation (DGON)
- Member of steering committee „Vermessung“ of Forschungsgesellschaft für Straßen- und Verkehrswesen (FGSV)
- Corresponding member of the „Strategic Advisory Group for Telematic Applications for Transport and Related Services“
- Member of Traffic Research Group at the University of Stuttgart
- Member of Deutsche Verkehrswissenschaftliche Gesellschaft (DVWG)
- Member of Working Group „Vermessung und Abnahme Feste Fahrbahn“ of Deutsche Bahn AG
- Coordinator of Working Group „Traffic Guidance and Control“ of IAG
- Speaker of the directory of Centre of Infrastructure Planning of the University of Stuttgart
- Speaker of the Centre of Transportation Research at Stuttgart University (FOVUS).

Ulrich Hangleiter:

- Member of the IASS (International Association of Shell and Spatial Structures)
- Secretary of the IASS Working Group 6 „Membrane and Tension Structures“

Heiner Kuhlmann:

- Member of Working Group „Vermessung und Abnahme Feste Fahrbahn“ of Deutsche Bahn AG
- Member of Working Group „Absteckung und vermessungstechnische Kontrolle“ of Forschungsgesellschaft für Straßen- und Verkehrswesen (FGSV)

## Education - Lecture / Practice / Training / Seminar

Surveying I, II for Civil Engineers (Möhlenbrink)	3/1/3/0
Surveying for Architects (Möhlenbrink)	2/0/1/0
Surveying Engineering and Mapping for Infrastructure Planning (Möhlenbrink)	2/0/0/0
Fundamentals to Surveying for Geodesists (Möhlenbrink)	3/2/0/0
Information Studies for Geodesists II (Wiltschko)	2/2/0/0
Adjustment Theory and Statistics I, II, III (Möhlenbrink)	5/3/0/0
Surveying I, II for Geodesists (Kuhlmann)	3/2/0/0
Field Practica in Surveying (Kuhlmann)	10 days
Special Tasks in Surveying (Kuhlmann, Eichhorn)	2/1/0/0



---

Cadastral Survey (Dünisch)	1/1/0/0
Field Practica in Cadastral Survey (Dünisch)	4 days
Surveying Engineering I, II, III (Möhlenbrink, Kuhlmann)	4/3/0/0
Structural Analysis for Geodesists (Hangleiter)	2/0/0/0
GIS-Supported Design of Road Tracks (Bettermann)	2/0/0/0
Digital and Thematic Cartography (Bettermann)	1/2/0/0
Adjustment and Analysis of Geodetic Networks (Bahndorf)	2/1/0/0
Analytical Formfinding of Lightweight Structures (Linkwitz)	2/0/0/0
Geodetic Seminar I, II (Fritsch, Grafarend, Keller, Kleusberg, Möhlenbrink)	0/0/0/4
Land Consolidation I, II (Mayer)	3/0/0/0
Land Classification and Evaluation (Gekle)	2/0/0/0





## Institute of Geodetic Science

Geschwister-Scholl-Str. 24/D, D-70174 Stuttgart,  
 Tel.: +49 711 121 3390, Fax: +49 711 121 3285  
 e-mail: [gis@gis.uni-stuttgart.de](mailto:gis@gis.uni-stuttgart.de) or [SECONDNAME@gis.uni-stuttgart.de](mailto:SECONDNAME@gis.uni-stuttgart.de)  
 url: <http://www.uni-stuttgart.de/gi>

### Head of Institute

Prof. Dr.-Ing. habil. Dr.tech.h.c.mult. Dr.-Ing.E.h.mult. Erik W. GRAFAREND  
 Prof. Dr. sc. techn. Wolfgang KELLER  
 Dr.-Ing. Friedrich KRUMM

Secretary: Anita VOLLMER

### Academic Staff

Dr.-Ing. M.Sc. Amir ABOLGHASEM	Dynamic Geodesy
Dr.-Ing. M.Sc. Alireza ARDALAN	Orbit Determination
Dipl.-Ing. Gerrit AUSTEN (since 1.12.)	Satellite Geodesy
M.Sc. Joseph AWANGE	Positioning
M.Sc. Jianqing CAI	Statistics
Dr.-Ing. Johannes ENGELS	Dynamic Isostasy
Dipl.-Ing. Andreas GILBERT	Wavelets
Dipl.-Ing. Simone HANKE Physical	Geodesy
Dipl.-Ing. Andreas HENDRICKS	Mathematical Geodesy
Dipl.-Ing. Christof SCHÄFER	Satellite Geodesy
Dipl.Ing. Beate SCHRAMM (since 15.1.)	Satellite Geodesy
Dr.-Ing. Volker S. SCHWARZE	Physical Geodesy
Dr.-Ing. M.Sc. Behzad VOOSOGHI	Deformation Analysis

## Administrative/Technical Staff

Dipl.-Ing. (FH) Wolfgang BAYERLEIN  
 Phys. T.A. Margarete HÖCK  
 Katja LANGER  
 Dipl.-Ing. (FH) Konrad RÖSCH  
 Andreas SCHWARZ

## Guests

Prof. Dr. Paul CROSS (London, England) 28.2.-2.3.  
 Paul CRUDDACE (Southampton, England) 28.2.-2.3.  
 Prof. Dr. Athanasios DERMANIS (Thessaloniki, Griechenland) 1.2.-17.5.  
 Prof. Fei GAO (Hefei, China) 10.10.-31.12.  
 Dr. Jonathan ILIFFE (London, England) 28.2.-2.3.  
 Dr. El Sayed ISSAWY (Kairo, Ägypten) 4.7.-31.8.  
 Prof. Dr. Juhani KAKKURI (Helsinki, Finnland) 25.1.-10.2., 18.4.-20.4.  
 Prof. Dr. Karoly I. KIS (Budapest, Ungarn) 13.11.-27.11.  
 Prof. Dr. Kurt KUBIK (Brisbane, Australien) 1.1.-29.2.  
 Prof. Dr. Zdenek MARTINEC (Prag, Tschechische Republik) 1.3.-31.8.  
 Yunzhong SHEN (Shanghai, China) 1.1.-31.8.  
 Dr. Martin VAN GELDEREN (Delft, Niederlande) 3.4.-7.4.  
 Prof. Dr. Peter VARGA (Sopron, Ungarn) 29.2.-31.3., 30.5.-30.6., 1.11.-15.12.  
 Prof. Dr. Peiliang XU (Kyoto, Japan) 1.1.-25.1.  
 Prof. Dr. Jozsef ZAVOTI (Sopron, Ungarn) 13.11.-27.11.

## Additional Lecturers

Prof. Dipl.-Ing. Manfred HINTZSCHE, Direktor, Stadtmessungsamt Stuttgart  
 Dr.-Ing. Burghard RICHTER, Deutsches Geodätisches Forschungsinstitut, München  
 Präsident Dipl.-Ing. Hansjörg SCHÖNHERR, Landesvermessungsamt Baden-Württemberg,  
 Stuttgart

# Research

## Ocean circulation from CHAMP data

Present orbit models for altimeter satellites and models for the stationary sea-surface topography have considerable errors in the length-scale 1000 - 4000 km. Gravity field models derived

from CHAMP orbit observations will improve the knowledge about the gravity field in exactly this spectral band. Based on the improved gravity field new orbits for the altimeter satellites could be computed. Since orbit computation is a very complex task, a technology for incremental orbit improvement exclusively due to changes in the gravity field model was developed. With the help of the incremental orbit improvement technique a radial orbit accuracy of 1cm for a complete repeat cycle of the ERS1/2 satellite could be achieved.

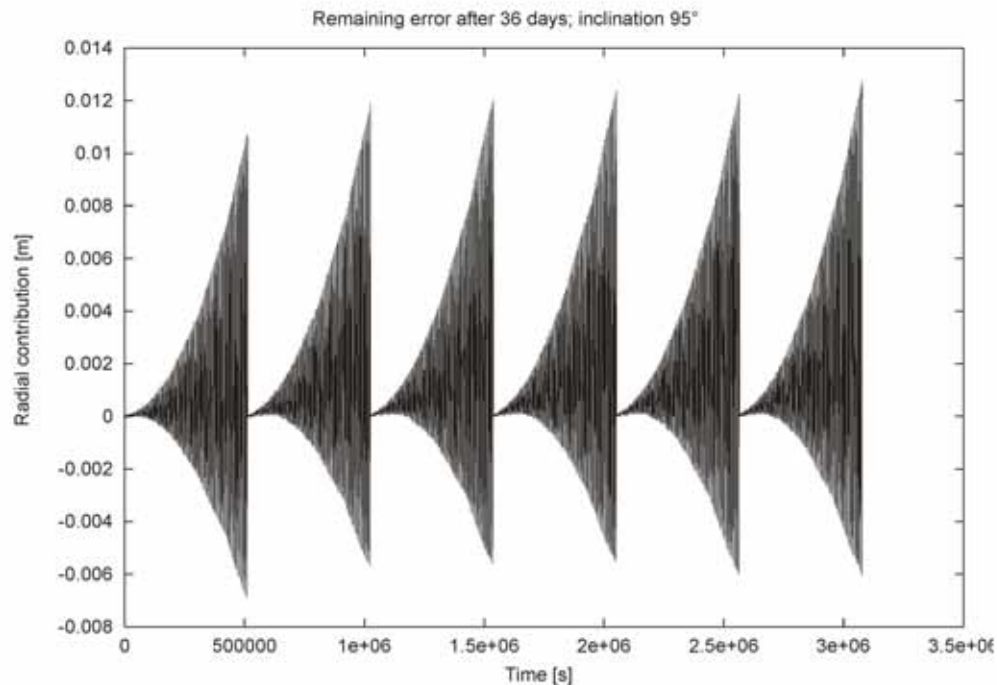

A reprocessing of the ERS1/2 altimeter data based on the improved orbits will be the next step. The final step of the DFG-sponsored project will be the assimilation of the CHAMP-improved geoid model and of the reprocessed altimeter sea-surface heights into the ocean circulation model LSG of the Alfred-Wegener-Institute (AWI) in Bremerhaven.

## Wavelet Application in Geodesy and Geodynamics

Wavelets are a recently developed tool for the analysis and interpretation of signals of various types. Compared to Fourier analysis, the standard tool for digital signal processing, wavelets provide two appealing features: (1) localization both in the time- and in the frequency domain and (2) discrete wavelet transformation algorithms, which are numerically even more efficient than the FFT. The DFG sponsored wavelet project aimed at an utilization of these properties in four fields of geodetic applications:

1. Data compression. For an optimal compression of smooth data like geoid undulations or geoid heights the underlying wavelet has to be both smooth and orthogonal. As the results of the investigations a wavelet, derived from the quadratic spline wavelet showed the best overall performance for different types of data. Wavelet analysis and synthesis algorithm tailored to this special wavelet were developed.

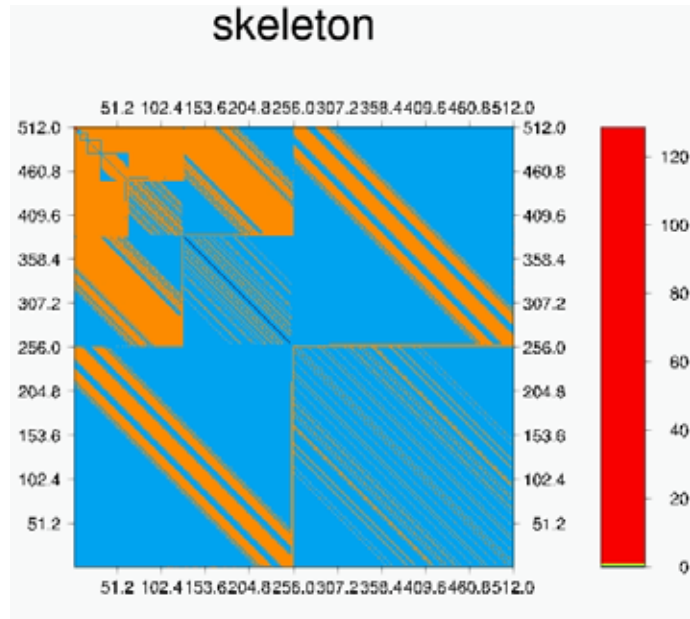

2. Operator compression. Weak singularities are a typical feature of kernels of geodetic integral formulas. Using wavelets for their discretization thanks to the localization property of wavelets a very sparse matrix structure can be obtained. Then sparse matrix techniques can be applied for a numerically efficient treatment of the integral equation. Even more: Diagonality of the system matrix can be obtained, if the signal and the data are represented by different specially designed base function systems: wavelets and vaguelettes. For the planar approximation of the Stokes operator a corresponding wavelet-vaguelette pair together with the corresponding decomposition and reconstruction algorithms were developed.

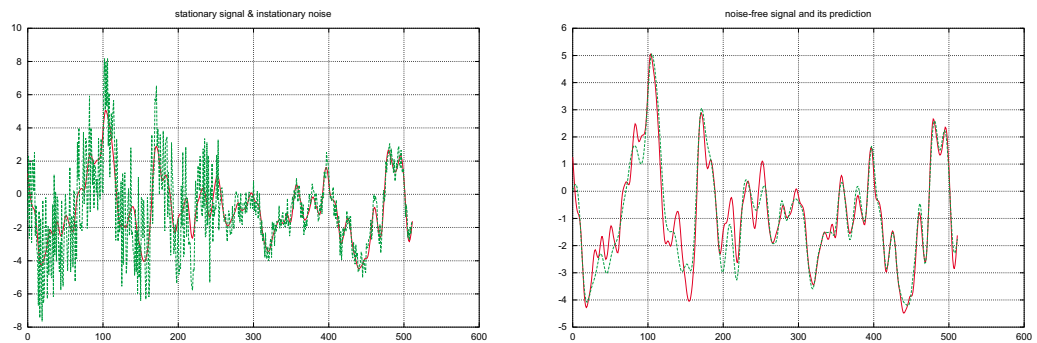

3. Non-stationary collocation. Under the stationarity assumption the Wiener-Kolmogorov equations of collocation theory become convolution equations and can efficiently be solved by FFT techniques. In reality many data exhibit instationarities and the resulting Wiener-Kolmogorov equations are non-convolution integral equations. Applying the above mentioned operator compression techniques efficient numerical algorithms for the non-stationary case could be developed. For example this technique can be applied to filter a signal with varying noise intensity.

The international cooperation in the field of wavelet application was organized in the framework of the IAG Special Study Group 4.187. One important outcome of this cooperation is a wavelet package for the most common wavelet algorithms both in a command-line driven C version as in a platform independent JAVA version. Both versions can be downloaded from the SSG 4.178 homepage <http://www.uni-stuttgart.de/iag>.

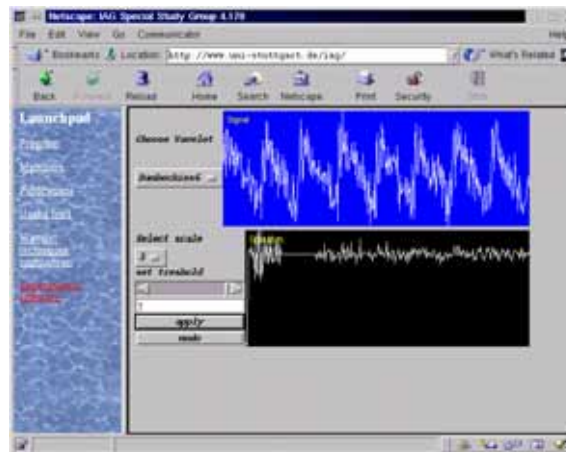

## Geoid Determination using Deflections of the Vertical

The basic idea for the geoid determination from surface covering vertical deflections consists of the following steps: First the astronomical observations are reduced using a spheroidal potential field of high resolution (order/degree 360/360). The deflections of the vertical which are now relieved from the gravitational field of the crust are reduced for the terrain effect in the second removal step. The disturbing potential and its horizontal derivative (the deflection of the vertical) is calculated in the measurement points on the Earth surface from the Dirichlet boundary value problem in form of a modified Abel-Poisson integral. Its inversion leads - in discrete terms and Tykhonov-Phillipps regularized - to the disturbing potential with respect to the international reference ellipsoid (world datum 2000). In two subsequent restore steps the terrain reduction and the spheroidal normal field with respect to the international reference ellipsoid are added to the disturbing potential. Finally discrete data of the disturbing potential are converted to ellipsoidal geoid undulations using the ellipsoidal Bruns transformation.

## Numerical Representation of Post-Seismic Displacement Fields

As an alternative to analytical representation of displacement fields due to different deformation sources, for instance dislocation sources and surface loads, a numerical method is tested. Finite element technique, as the proper solution method is applied in computing the displacement field of different Earth models. In some cases, where the analytical solution is available, a comparison is made. The following Earth models have been investigated: (1) Incompressible homogeneous isotropic linear elastic sphere, (2) incompressible pre-stressed homogeneous isotropic linear elastic sphere, (3) incompressible homogeneous isotropic linear viscoelastic sphere, (4) incompressible pre-stressed radially homogeneous isotropic linear viscoelastic sphere and (5) incompressible pre-stressed isotropic linear viscoelastic sphere, with different thicknesses of lithospheric layer. The last model comprises a liquid core, viscoelastic upper- and lower mantle, and a two part elastic lithosphere, an oceanic plate of 150 km thickness, and a continental plate of 50 km thickness. A horizontal slip was formulated on the border of the two lithosphere plates, and the surface displacement field was computed.

## Dynamic Isostasy and Polar Wandering

The aim of this research project is to generalize the common statical Heiskanen-Vening-Meinesz-model to the dynamical viscoelastic case with rotation as well as to a spherical or ellipsoidal boundary geometry, respectively. In particular, the deformation of the earth's body due to surface loading is investigated. Furthermore the temporal variation of the earth's rotation vector due to the incremental inertia tensor is considered, which results from load and deformation.

The viscoelastic case can be treated by Biot's correspondence principle: The Laplace-transformed, linearized equations of motion have for a fixed frequency the same form as



the elastic-statical equilibrium conditions. The determining equations for the radius-dependent coefficient-functions of the vector spherical harmonics show characteristic defects, which are due to the quasistatic approximation. Besides the equation of momentum therefore also the equations of angular momentum as well as the system definition of the rotating systems (e.g. Tisserand-system, system of vanishing surface vorticity) are needed. In contrast to the usual calculation method the displacement components and the incremental rotation vector are determined from a coupled linearized system of equations, taking consequently into account the inertial and the ellipsoidal terms. For the case of a homogeneous, ellipsoidal, viscoelastic, incompressible earth and a surface load, which is characterized by a temporal Heaviside function, the results of the usual method are essentially confirmed. However, a (though small) true polar wander could be demonstrated, which in the framework of the usual method only for layered models appears.

In the period of the report mainly the calculation of layered models was forced. Since there are boundary conditions at the earth's surface as well as at the core-mantle-boundary, the external boundary conditions are propagated downwards analytically. The resulting linear equation system for the unknown coefficients of the displacement field, the incremental gravity field and the polar motion has to be solved semi-analytically: The elements of the inverted matrix of the linear equation system can be represented as fractions of polynomials in the Laplace parameter  $s$ . The zeros of the nominators and the denominators are determined numerically. Every zero of the denominator corresponds to a fading exponential term in the time domain (inverse Laplace-transformation). The retransformed elements are to be convoluted with the boundary values, which contain the coefficients of the exciting loading potential.

## Earth Surface Deformation Analysis

Lagrangian and Eulerian deformation tensors are a key tool in the study of deformation. Although many methods have been proposed to calculate deformation tensor fields of the Earth surface, only few refer to the real surface of the Earth. Most of these methods formulate the problem on reference surfaces such as projection plane or sphere and consequently their results suffer from possible effects of incompleteness in the mathematical models of projections. Deformation tensors and their associated invariants are critical for a meaningful study of deformations and kinematics of the Earth. Moreover, their geodetic estimates are crucial as initial values for geophysical models as well as quantifying potential seismic activities.

Here we present a method of differential geometry that allows deformation analysis of the real surface of the Earth on its own rights for a more reliable and accurate estimate of the surface deformation measures. The method takes advantage of the simplicity of the 2-dimensional surface geometry versus 3-dimensional spaces without losing or neglecting information and effect of the third dimension in the final results. The dissertation describes analytical modeling, derivation and implementation of the surface deformation measures based on the proposed method with particular attention to the formulation and implementation of the tensors of linearized rotation and change of curvature in Earth deformation studies.

Finally the method is applied to a real data set of space geodetic positions and displacement vectors. This application reveals capabilities and strengths of the developed mathematical models of the suggested method. Contemporary kinematics of Europe and Mediterranean area is studied based on positions and rates of displacement vectors of nearly 100 points of the ITRF97 solution.

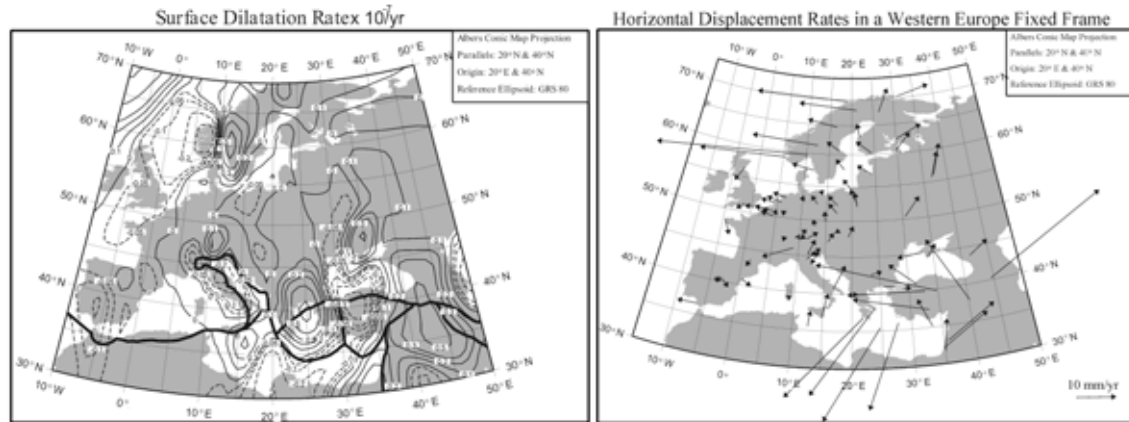

### Threedimensional GPS/LPS positioning

The challenges brought by the Global Positioning System (GPS) has necessitated the redesign of the hitherto two dimensional local positioning networks into three dimensional positioning mode. The Local Positioning Systems (LPS) procedures such as traversing, resection, intersection "Bogenschnittäre all constrained to be designed in three dimensional mode. The design of the LPS system in three dimensional positioning mode brings with it the three dimensional orientation problem since the LPS systems operate in the Local Level Reference Frame while the GPS system operate in the Global Reference Frame. The solution to the three dimensional orientation problem is achieved by the application of the Simple Procrustes Algorithm or Partial Procrustes Algorithm. In so doing the direction of the local gravity vector namely the astronomic longitude and astronomic latitude are produced thereby alleviating the tedious and tiresome night astro-nomic observations which are also weather dependent.

The leap from the two dimensional positioning procedures other than giving birth to the three dimensional orientation problem comes along with more complicated non-linear equations which have to be solved for the unknowns. Examples here include the three dimensional distance „Grunert“ equations for three dimensional resection problem, "Bogenschnitt"equations, GPS / GLONASS pseudorange equations for the unknown receiver station's coordinates and receiver clock bias, and the minimum distance mapping problem that projects the topographical point onto the (reference) ellipsoid of revolution. The solution to this non-linear equations has been to linearize the equations and use approximate values within the framework of Least Squares Esti-

mation (LSE) and iterate to convergence. To avoid the iterative procedures which depend highly on the approximate values chosen, some of which are difficult to choose as evidenced in some geodetic procedures unlike in photogrammetry, a direct solution of these non-linear equations by using the analytical approaches of Gröbner Bases and Multipolynomial Resultants to manipulate algebraic equations elements of polynomial rings is adopted.

In practice, more observations are normally gathered than is required to solve for the unknowns (also referred to as indeterminate or variables in algebraic language). The P. Werkmeister combinatorial lemma is investigated with the aim of providing an alternative procedure to LSE in solving non-linear Gauss-Markov model but with the advantage of not requiring the initial approximate values and iterative steps. The P. Werkmeister combinatorial is applied to the nonlinear adjustment of GPS observations of type code and phase pseudo-ranges in two steps. In step one, a combinatorial minimal subset of observation is constructed which is rigorously converted into station coordinates by means of Gröbner basis algorithm or Multipolynomial resultant algorithm. The combinatorial solution points in a polyhedron are reduced to their barycentric in step two by means of their weighted mean. Such a weighted mean of the polyhedron points in  $\mathbb{R}^3$  is generated via the Error Propagation law/variance-covariance propagation. The figure illustrates the scatter of 14 combinatorial solution points around the barycentric solution (indicated by a triangle) for the case of six GPS satellites.

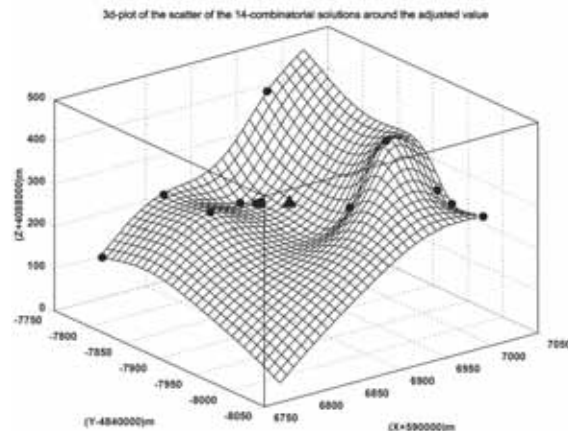

## Datumtransformations, Geodetic Reference Frames

The adoption of the European Terrestrial Reference System ETRS89 as the future national reference system in Germany lead to the question how to efficiently perform the transition from the old coordinates to the new ones. For this reason direct transformation equations of polynomial type have been developed. The highest order of these polynomials which are necessary to guarantee a sufficient accuracy of the transformation has been determined from several case studies in

Germany. The polynomial coefficients were determined from sets of identical points. Concerning the three dimensional datum transformation (similarity transformation) of cartesian coordinates from one datum into another a further attempt was made to introduce the famous and advantageous Procrustes algorithm/transformation. This algorithm computes the seven transformation parameters of the conformal group without linearization of the observation equations and needs no iteration as compared to the usually applied adjustment procedures. In addition, the a priori variance-covariance information of identical points has been taken into account.

## Map Projections, Harmonic Maps

In order to compute harmonic maps the mapping equations have to fulfill the Laplace-Beltrami equation. As a starting point a homogeneous polynomial  $P_r(q, p)$  was set up with the condition that  $(\partial^2/\partial q^2 + \partial^2/\partial p^2)P_r(q, p) = 0$ . The corresponding polynomial coefficients were fixed using the boundary conditions that both the reference meridian and the equator should be mapped equidistantly and as straight lines. The transformation equations including distortion measures were derived.

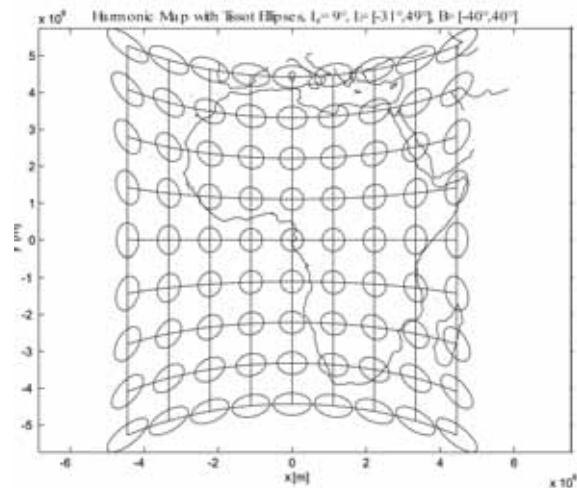

## Hypothesis tests and statistics of the eigenvalues and orientations of a random deformation tensor

The eigenspace components (principal components, principal directions) of a two or three dimensional symmetric rank two random tensor are highly important in geophysics. They play an important role in interpreting the geophysical phenomena, e.g. earthquakes, plate motions and

deformations. With the new space geodetic methods the continental plate motions can be measured with high accuracy. This fact motivates that the components of deformation tensor (stress or strain tensor) can be estimated from the high accuracy geodetic data and analyzed through proper statistical testing procedures. Deformation measures can be defined as the strain tensor and stress tensor, further the eigenvalue and eigenvector of the strain or stress tensor. Statistical inference on deformation measures are based on statistics, e.g. sample means and sample variance-covariance of these tensors.

On the assumption that a strain or stress tensor has been directly measured or derived from other observations such a three dimensional, symmetric  $(2, 0)$  tensor is a random tensor which we assume to be an element of the tensor-valued Gauss normal distribution of type independently, identically distributed (i.i.d.) tensor-valued observations. It is proven that the vectorized random tensor has a BLUE as well as a robust  $\alpha$ -weighted minimum variance/minimum bias BLE (also called „ridge type“) estimate which is multivariate normal. The BIQUUE sample variance-covariance matrix is Wishart distributed. The exact distribution of the eigenspace components of the  $(2, 0)$  random tensor (principal components, principal directions) has been investigated: It is significantly different from commonly used Gauss normal distribution. Since there is no exact integral solution to the exponential function of the exact distribution functions the marginal probability density functions of random eigenvalues are solved by numerical analysis with the power series expansion of the exponential item, which are proper compared with the special solution under the condition of invariant rotation. The inference on the deformation measures are also studied.

## List of Publications

- ARDALAN A and AWANGE J L (2000): Compatibility of the NMEA GGA with GPS receivers. GPS Solutions 3 (2000) 1-3
- GILBERT A and KELLER W: Deconvolution with wavelets and vaguelettes. Journal of Geodesy 74 (2000) 306 - 320
- GRAFAREND E: The time-varying gravitational potential field of a massive, deformable body. Studia geoph. et geod. 44 (2000) 364-373
- GRAFAREND E: Mixed integer-real valued adjustment (IRA) problems, GPS Solutions (Wiley Publ.) 4 (2000) 31-45
- GRAFAREND E, HENDRICKS A and GILBERT A: Transformation of conformal coordinates of type Gauß-Krüger or UTM from a local datum (regional, National, European) to a global datum (WGS 84, ITRF 96), Part II, Case studies, Allgemeine Vermessungsnachrichten 107 (2000) 218-222
- GRAFAREND E, ENGELS J and VARGA P: The temporal variation of the spherical and Cartesian multipoles of the gravity field: the generalized MacCullagh representation. Journal of Geodesy 74 (2000) 519-530

GRAFAREND E and AWANGE J: Determination of vertical deflections by GPS/ LPS measurements. Zeitschrift für Vermessungswesen 125 (2000) 279-288

KELLER W: A wavelet approach to non-stationary collocation. In: Schwarz K P (ed): Geodesy Beyond 2000. Springer-Verlag, Berlin-Heidelberg-New York., 208 - 214

## Doctoral Theses

ABOLGHASEM Amir: Numerical modeling of post-seismic displacement fields (16.8.)

ARDALAN Alireza: High resolution regional geoid computation in the world geodetic datum 2000; based upon collocation of linearized observational functionals of the type GPS, gravity potential and gravity intensity (29.2.)

SCHÄFER Christof: Space gravity spectroscopy: The sensitivity analysis of GPS-tracked satellite missions (case study CHAMP) (25.7.)

VOOSOGHI Behzad: Intrinsic deformation analysis of the Earth surface based on 3-dimensional displacement fields derived from space geodetic measurements (16.10.)

## Diploma Theses

BÖHRINGER Joachim: Variational equations for the incremental orbit improvement (Supervisor: W. Keller)

AUSTEN Gerrit und REUBELT Tilo: Räumliche Schwerefeldanalyse aus semi-kontinuierlichen Ephemeriden niedrigfliegender GPS-vermessener Satelliten vom Typ CHAMP, GRACE und GOCE (Spatial gravity field analysis using semi-continuous ephemerides of low orbiting GPS-tracked satellites CHAMP, GRACE, GOCE; Supervisor: E. Grafarend)

## Study Theses

AUSTEN Gerrit: Erstellung von ID-Cards ausgewählter Zylinderabbildungen der Kugel und des Rotationsellipsoides (Construction of ID-Cards of selected cylindrical projections of the sphere and the ellipsoid of revolution; Supervisor: E. Grafarend)

BERNHARDT Tilo: Gewichtsiterierter Prokrustes-Algorithmus (The Procrustes algorithm with iterated weights; Supervisor: E. Grafarend)

HOCH Andreas: Charting Celtic burying fields applying real-time GPS (Supervisor: W. Keller)

KREHL Tobias: Generalization of target-visibility algorithms for SAR and optical remote sensing instrument in the satellite mission planning (Supervisor: W. Keller)

REUBELT Tilo: Analyse der Satellitenbewegungsgleichung mit Hilfe kartesischer Bahnkoordinaten am Beispiel des CHAMP-Satelliten (The analysis of the satellite equation of motion using cartesian orbit coordinates, case study: The CHAMP satellite; Supervisor: E. Grafarend)

## Lectures at other universities and at conferences

- ARDALAN A: High Resolution Regional Geoid Computation in the World Geodetic Datum 2000 based upon collocation of linearized observational functionals of the type GPS, gravity potential and gravity intensity. Geodätische Woche 2000, GeoForschungsZentrum Potsdam, 10.-12. Oktober 2000
- ARDALAN A : Toward a Spheroidal Gravitational Earth Model (SEGM 2000) Spheroidal Harmonic Analysis on the International Reference Ellipsoid. Geodätische Woche 2000, GeoForschungsZentrum Potsdam, 10.-12. Oktober 2000
- AWANGE J : Nonlinear adjustment of GPS observations of type pseudo-range and phase: the Werkmeister combinatorial algorithm. Geodätische Woche 2000, GeoForschungsZentrum Potsdam, 10.-12. Oktober 2000 CAI J: The sampling distribution of the sample means and sample variance-covariance of a two dimensional, symmetric rank two random tensor (strain, stress). Geodätische Woche 2000, Geo-ForschungsZentrum Potsdam, 10.-12. Oktober 2000
- GRAFAREND E: Satellitengeodäsie - insbesondere Bahnbestimmung (Technische Hochschule Darmstadt)
- GRAFAREND E: Konformismus, geodätische Flüsse, Dialoge zwischen Gauß-Legendre, Maupertuis-Jacobi und Soldner-Fermi. Universität der Bundeswehr Fakultät für Bauingenieur- und Vermessungswesen, München, 25. Februar 2000
- GRAFAREND E: High resolution geoid computation from potential data (gravimetric levelling) and gravity data (gravity survey) as well as GPS. Geographical Survey Institute (GSI), Tsukuba Science City, Japan, 6. - 11. März 2000
- GRAFAREND E: World Geodetic Datum 2000. Geographical Survey Institute (GSI), Tsukuba Science City, Japan, 6. - 11. März 2000
- GRAFAREND E: Space gravity spectroscopy. Case study: The Champ satellite. Geographical Survey Institute (GSI), Tsukuba Science City, Japan, 6. - 11. März 2000
- GRAFAREND E: Terrain reduction - topographic reduction of the gravitational potential and the modulus of gravitational field intensity in a moving tangent space. European Geophysical Society, XXV General Assembly, Millenium Conference on Earth, Planetary and Solar System Sciences, Nice / France, 25.-29. April 2000
- GRAFAREND E: High resolution regional Geoid computation in the World Geodetic Datum 2000 based upon collocation of linear observational functionals of type GPS, potential data (gravimetric leveling) and gravity intensity data (gravity survey), case study: State of Baden-Württemberg. Workshop Perspectives of Geodesy in South-East Europe, Inter University Centre Dubrovnik, Dubrovnik / Croatia, 2.-6. Mai 2000
- GRAFAREND E: Champ, Grace, Goce. Drei neue Satellitenmissionen zur Hyperfeinstruktur des terrestrischen Gravitationsfeldes: Space Gravity Spectroscopy. 50. Ulrich - Dehlinger - Kolloquium in memoriam Prof. Dr. Dr. h.c.mult. Ekkehart Kröner, Institut für Theoretische

- und Angewandte Physik, Universität Stuttgart / Max-Planck-Institut für Metallforschung, Stuttgart, 7. Juli 2000
- GRAFAREND E: Homogeneity and isotropy of incremental stochastic processes on the sphere, case study: the gravity field of the Earth. International Conference on Spatial Statistics in the Agro-, Bio- and Geosciences, Institut für Stochastik, Technische Universität Bergakademie Freiberg, 19.-22. Juli 2000
- GRAFAREND E: World Geodetic Datum 2000. Gravity, Geoid, Geodynamics 2000, IAG International Symposium, The Banff Centre for Conferences, Banff / Alberta / Canada, 31. Juli - 4. August 2000
- GRAFAREND E: Earth surface deformation analysis portraying vertical and horizontal deformations patterns of the northern European region. Gravity, Geoid, Geodynamics 2000, IAG International Symposium, The Banff Centre for Conferences, Banff / Alberta / Canada, 31. Juli - 4. August 2000
- GRAFAREND E: High resolution regional geoid computation in the World Geodetic Datum 2000 based upon collocation of linearized observational functionals of type GPS, gravity potential and gravity intensity. University of Calgary, Department of Geomatic Engineering, 4. August 2000
- GRAFAREND E: Polynomische geodätische Beobachtungsgleichungen und ihre strenge Lösung. Technische Universität Graz, Institut für Ingenieurvermessung und Meßtechnik, 26. September 2000
- GRAFAREND E: Das Datumproblem in geodätischen Beobachtungsgleichungen. Technische Universität Graz, Institut für Ingenieurvermessung und Meßtechnik, 27. September 2000
- GRAFAREND E: Das lineare spezielle Gauss-Markov Modell mit fixen Effekten. Technische Universität Graz, Institut für Ingenieurvermessung und Meßtechnik, 28. September 2000
- GRAFAREND E: Das lineare spezielle Gauss-Markov Modell mit stochastischen Effekten. Technische Universität Graz, Institut für Ingenieurvermessung und Meßtechnik, 3. Oktober 2000
- GRAFAREND E: Das allgemeine nichtlineare Gauss-Markov Modell: „Stochastische Linearisierung“ (stochastische Vorinformation). Technische Universität Graz, Institut für Ingenieurvermessung und Meßtechnik, 4. Oktober 2000
- GRAFAREND E: Das gemischte Modell (allgemeines lineares Gauss-Markov Modell mit fixen Effekten und Zufallseffekten). Technische Universität Graz, Institut für Ingenieurvermessung und Meßtechnik, 5. Oktober 2000
- GRAFAREND E: The spherical horizontal and spherical vertical boundary value problem - vertical deflections and geoidal undulations - the completed Meissl diagram. Geodätische Woche 2000, GeoForschungsZentrum Potsdam, 10.-12. Oktober 2000



- GRAFAREND E: Green's function solution to gradiometric boundary-value problems. Geodätische Woche 2000, GeoForschungsZentrum Potsdam, 10.-12. Oktober 2000
- GRAFAREND E: Mixed integer-real valued adjustment (IRA) problems: GPS initial cycle ambiguity resolution by means of the LLL-algorithm. Geodätische Woche 2000, GeoForschungsZentrum Potsdam, 10.-12. Oktober 2000
- GRAFAREND E: Space gravity spectroscopy am Beispiel Champ. Geodätische Woche 2000, GeoForschungsZentrum Potsdam, 10.-12. Oktober 2000
- GRAFAREND E: The spectacular new gravimetric satellite missions: CHAMP, GRACE, GOCE. Lecture Series, Wuhan University, Wuhan / China, 5.-7. November 2000
- GRAFAREND E: High resolution regional geoid computation in the World Geodetic Datum 2000 based upon collocation of linearized observational functionals of type GPS, gravity potential and gravity intensity. Lecture Series, Wuhan University, Wuhan / China, 5.-7. November 2000
- GRAFAREND E: The World Geodetic Datum 2000. Lecture Series, Wuhan University, Wuhan / China, 5.-7. November 2000
- GRAFAREND E: High resolution geoid computation. Lecture Tongji University, Shanghai / China, 9. November 2000
- KELLER W: Wavelet Applications in Geodesy and Geodynamics (University of Calgary/Canada), August 2000 (<http://www.uni-stuttgart.de/iag>)
- KELLER W: A wavelet solution to non-stationary 2D-collocation. Gravity, Geoid, Geodynamics 2000, IAG International Symposium, The Banff Centre for Conferences, Banff / Alberta / Canada, 31. Juli - 4. August 2000
- KRUMM F: Three-dimensional Datum Transformation: The Weighted Procrustes Algorithm. Gravity, Geoid, Geodynamics 2000, IAG International Symposium, The Banff Centre for Conferences, Banff / Alberta / Canada, 31. Juli - 4. August 2000
- KRUMM F: Datum free Deformation Analysis of ITRF networks. Gravity, Geoid, Geodynamics 2000, IAG International Symposium, The Banff Centre for Conferences, Banff / Alberta / Canada, 31. Juli - 4. August 2000

## Activities in National and International Organizations

ENGELS J:

Member Special Study Group 4.189 (IAG): "Dynamic theories of deformation and gravity fields"

GRAFAREND E W:

Member Examining Board „Studiengang Vermessungswesen“  
External Examiner, University South East London, UK

External Examiner, University of Nairobi, Nairobi, Kenya  
 Member German Geodetic Commission at the Bavarian Academy of Science  
 Member German Physical Society  
 Member German Geophysical Society  
 Member Gauß-Society e.V.  
 Chairman Scientific Committee German Geodetic Research Institute  
 Member „Deutscher Verein für Vermessungswesen“  
 Member „Deutscher Markscheideverein“  
 Member „Auswahlausschuss Alexander-von-Humboldt-Stiftung“  
 President of the Special Commission Section IV (IAG), SC1: „Mathematical and Physical Foundations of Geodesy“  
 Member Special Commission Section V (IAG), SC3: „Fundamental Constants (SCFC)“  
 Member Special Study Group 5.147 (IAG): „Studies of the Baltic Sea“  
 Member Special Study Group 2.109 (IAG) „Application of Space VLBI in the Field of Astrometry and Geodynamics“  
 Member Royal Astronomical Society  
 Member American Geophysical Union  
 Member Bernoulli Society  
 Member Flat Earth Society

GRAFAREND E W, KELLER W:

Members „Promotionsausschuß“  
 Members „erweiterter Fakultätsrat der Fakultät für Bauingenieur- und Vermessungswesen“  
 Members „Studienkommission Vermessungswesen“

HENDRICKS A:

Member „Deutscher Verein für Vermessungswesen“  
 Member Working Group „Cartography and Geoinformation“, National Standardization Institute of Germany

KELLER W:

Member German Mathematical Society  
 President of IAG Special-Study Group 4.187 „Wavelets in Geodesy and Geodynamic“

SCHÄFER Ch:

Member „Deutscher Verein für Vermessungswesen“  
 Member Working Group Cartography and Geoinformation“, National Standardization Institute of Germany

SCHWARZE V. S.:

President IAG Special Commission 1, Subcommission 4: „Geometry, Relativity, Cartography, GIS“

Member „Deutscher Verein für Vermessungswesen“

## Education - Lecture/Practice/Training/Seminar

Applied Graph Theory (Grafarend)	2/1/0/0
Adjustment and Statistics III (Grafarend)	2/1/0/0
Differential Geometry for Geodesists (Grafarend)	2/1/0/0
Geodetic Astronomy I,II (Richter)	2/2/0/0
Geodetic Coordinate Systems (Keller)	1/1/0/0
Geodetic Seminar I,II (Fritsch/Grafarend/Keller/Kleusberg/Möhlenbrink)	0/0/0/4
Gravimetry and Earth Tides (Grafarend)	2/1/0/0
Introduction to Geodesy I,II (Grafarend)	2/1/0/0
Map Projections (Grafarend, Krumm)	2/1/0/0
Mathematical Geodesy I,II (Grafarend, Krumm)	2/2/0/0
Numerical Methods in Geodesy (Keller)	1/1/0/0
Physical Geodesy I,II (Engels, Grafarend)	3/2/0/0
Physical Geodesy III,IV (Keller)	4/2/0/0
Potential Theory and Special Functions (Keller)	2/1/0/0
Lab Satellite Geodesy I,II (Keller)	0/0/1/0
Lab Geodesy/Geodetic Astronomy (Grafarend/Richter)	0/0/1/0
Real-Estate Cadastre I,II (Schönherr)	4/0/0/0
Real-Estate/ Property Valuation I,II (Hintzsche)	2/1/0/0
Satellite Geodesy I,II (Keller)	2/2/0/0
Stochastic Processes for Geodesists (Keller)	2/1/0/0





## Institute of Navigation

Geschwister-Scholl-Str. 24/D, D-70174 Stuttgart,  
 Tel.: +49 711 121 3400, Fax: +49 711 121 2755  
 e-mail: [ins@nav.uni-stuttgart.de](mailto:ins@nav.uni-stuttgart.de)  
 homepage: <http://www.nav.uni-stuttgart.de>

### Head of Institute

Prof. Dr.-Ing. A. Kleusberg  
 Deputy: Dr.-Ing. Karl-Heinz Thiel  
 Secretary: Helga Mehrbrodt  
 Emeritus: Prof. em. Dr.-Ing. Ph. Hartl

### Staff

Dipl.-Ing. Jürgen Ming, Akad. Rat	Administration
Dipl.-Geogr. Frank Anselm	Thematic Mapping
Dipl.-Ing. Doris Becker	Navigation Systems
Dipl.-Ing. Felix Butsch	Navigation Systems
Dipl.-Ing. Denise Dettmering	Navigation Systems
Dipl.-Geogr. Thomas Gauger	Thematic Mapping
Ing. grad. Hans-Georg Klaedtke	Remote Sensing
Dipl.-Ing. Roland Pfisterer	Laser Systems
Dipl.-Phys. Manfred Reich	Interferometry
Dipl.-Ing. Oliver Schiele	Navigation Systems
Dipl.-Ing. Wolfgang Schöller	Education
Dipl.-Ing. Jürgen Schmidt	Interferometry
Dr.-Ing. Aloysius Wehr	Laser Systems
Dipl.-Ing. Karl Wörz	Interferometry
Dipl.-Ing. (FH) Martin Thomas	Laser Systems
MSC(IP) José Marcelo Zárate Encalada	Remote Sensing

### EDP and Networking

Regine Schlothan

## **Laboratory and Technical Shop (ZLW)**

Dr.-Ing. Aloysius Wehr (Head of ZLW)  
Dipl.-Ing. (FH) Erhard Cyranka  
Dipl.-Ing. (FH) Dieter Schweizer  
Technician Edmund König  
Technician Peter Selig-Eder  
Mech. Martin Böttger  
Mech. Master Fritz Huber

## **External teaching staff**

MSC Imam Mudita  
Dipl.-Ing. Sergey Gurin

## **External teaching staff**

Dr.-Ing. Gerhard Smiatek – Fraunhofer Institute for Atmospheric Environmental Research  
Dr.-Ing. Volker Liebig – Programme Directorate DLR-GE  
Dr.-Ing. Braun – RST Raumfahrt Sytemtechnik AG, St. Gallen

# **Research Projects**

## **Integrity of Satellite Navigation in Airborne Applications**

The DLR (Deutsches Zentrum für Luft- und Raumfahrt) project entitled ISAN (Integrity of Satellite Navigation) investigates the use of GPS or GNSS in all phases of flight especially during approach and landing. The ISAN project involves through participation of a number of collaborating German research institutions and private companies. The Institute of Navigation contributing in studies related to signal multipath and electromagnetic signal interference.

## **Signal Multipath**

In high precision applications of satellite navigation systems, a number of common measurement error sources is eliminated or greatly reduced by applying differential corrections provided by a reference station. One of the most severe remaining influences is then the signal multipath effect

that corrupts the GPS and GLONASS signals in almost all surroundings, especially in the vicinity of conducting material. Reflections of the GPS or GLONASS signals from nearby conducting objects can affect the signal at the user location and the ground reference station. New algorithms and software tools are developed and evaluated in order to reduce signal multipath effects.

## **Electromagnetic Interference**

When satellite navigation systems are used for air navigation, the threat of the reliability, integrity and precision by interfering signal is a very important concern. Within the ISAN (Integrity for Satellite Navigation) project the INS conducts laboratory tests of interference resistance of GPS and GLONASS receivers and field measurements near airports and other possibly electromagnetically contaminated sites.

The INS cooperates with the Deutsche Flugsicherung GmbH (DFS, German Air Navigation Services) in development and deployment of a GNSS Interference Monitoring System (GIMOS). GNSS interference monitoring means to observe signals that could be able to degrade the quality of GPS and GLONASS signals. For this purpose, all signals within the frequency range of GPS and GLONASS are received and their signal properties are evaluated in regular time intervals (e.g. once per second). The goal is to assess the impact on the satellite navigation signal and to gain information about the source of the interference signals.

## **Integrity of Satellite Navigation Data and Differential GPS Data in Land Applications**

Realtime positioning of land vehicles can be usually done by integrated systems consisting of satellite navigation systems, deadreckoning, and mapmatching. As the accuracy and integrity of these systems is often insufficient for high performance applications, the employment of differential satellite navigation has become an important technology.

One project of the INS is to analyse the availability, accuracy and integrity of the satellite navigation systems and the differential correction data in different environments. Especially in urban canyons, the satellite signals can be shaded or disturbed in such a way that optimal receiver quality can not be guaranteed. In order to give a detailed overview about the performance of differential satellite navigation in different situations, a complete evaluation of the situation will be provided.

## **High Precision 3D Positioning and Orientation System**

The Institute of Navigation operates a high precision Navigation Platform to support applications requiring very precise position and attitude data. The POS/DG platform from Applanix Corporation consists of three main components: a dual-frequency GPS-receiver, the POS Computer System (PCS) and a six degree of freedom Inertial Measurement Unit (IMU). The INS uses this system for geocoding airborne laser scanner data and as position reference system in land navigation applications.

## Ionospheric Effects

Information about the temporal and spatial variation of the earth's ionosphere are necessary to correct single frequency GPS/GLONASS measurements for ionospheric propagation errors which can easily exceed the 10 m level. Dual frequency GPS/GLONASS receivers can utilize the dispersive nature of the ionosphere, and directly measure the electron content integrated along the signal path, dubbed Total Electron Content (TEC). Ground based GPS/GLONASS measurements are not very sensitive to the vertical structure of the ionosphere and do not allow to recover the distribution of free electrons with height. To get three dimensional ionospheric models it is necessary to include dual frequency measurements from one or more spaceborne GPS/GLONASS receivers on Low Earth Orbiter (LEO). New algorithms and software tools are developed and evaluated in order to recover three dimensional ionospheric models and to improve our knowledge of the earth's upper atmosphere.

In addition to benign ionospheric effects there exist irregularities in electron density which cause rapid variations in the amplitude and the phase of the GPS signals. These scintillations lead to an increasing noise in GPS pseudorange and range rate measurements as well as to a rising probability of losing signal lock. In a BMBF-project, titled 'UniTaS', the INS investigates the impact of ionospheric scintillations on different GPS receivers, in different parts of the earth and at different times. The aim of the project is to get an overview of the influences of this ionospheric effects on the positioning accuracy and the integrity of GPS.

## Scanning Laser Altimeter (ScaLARS)

In the year 2000 the Institute for Navigation established an operational processing platform to derive digital terrain models (DTM) from digital surface models (DSM) obtained from airborne laser scanning. An surveyed area in Thuringia of more than 1000 km<sup>2</sup> were processed with this software platform. The DTMs were delivered in tiles of 5 km x 5 km to the Landesvermessungsamt Thüringen. The figures demonstrate that the used algorithms even reshape railroad tracks.

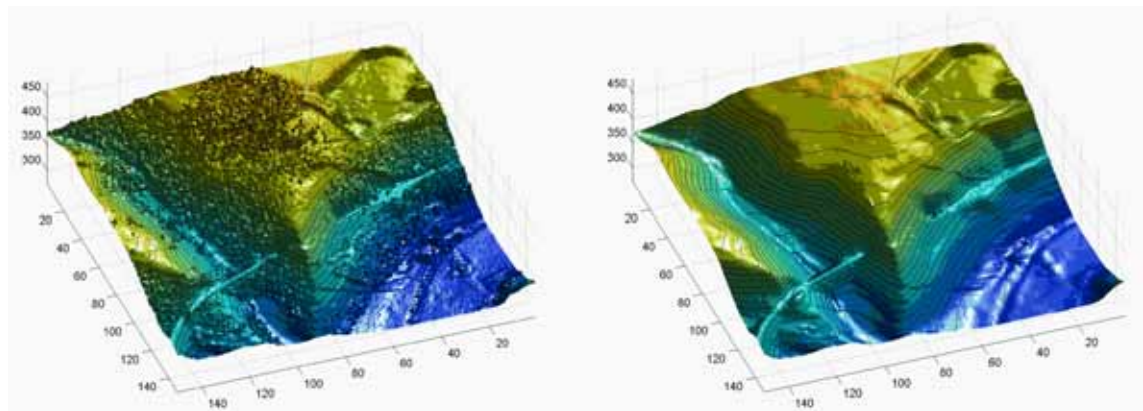



In late winter 2000 ScaLARS was utilized to measure snow elevations in areas endangered by snow avalanches in the Swiss Alps. Here we worked together with the Swiss Federal Institute for Snow and Avalanche Research in Davos, Switzerland. In autumn a surveying campaign was carried out in Taiwan. Here the INS worked together with the Institute for Photogrammetry of the Cheng Kung University of Tainan. The project was sponsored by the DAAD (Deutscher Akademischer Austauschdienst).

## Near range applications

The scientific Champ satellite developed by GeoForschungsZentrum Potsdam (GFZ) was digitized with our laser scanner for near range applications in Munich at the company IABG. The object was very challenging because it consists primarily of specular reflecting surfaces. More than 80 laser images were taken to obtain a comprehensive model. The independent 3D data sets of the different images were transformed in one global coordinate system by using small spheres.

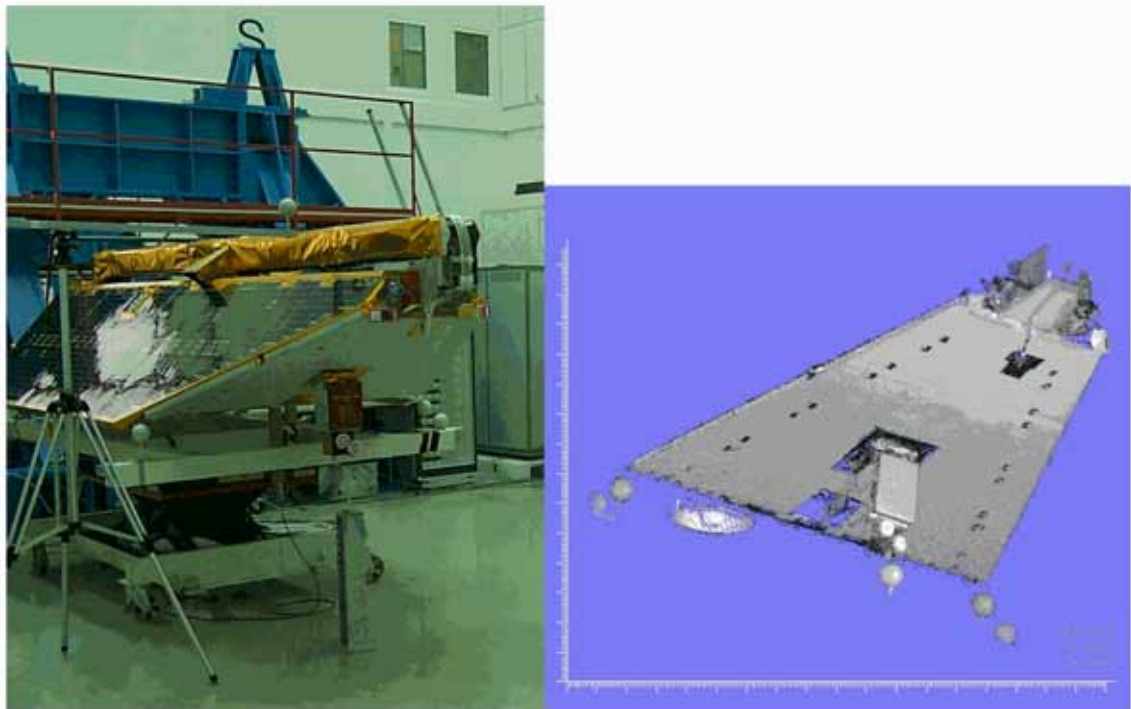

## Remote sensing of agricultural fields.

Satellite remote sensing of agricultural fields at INS is based on radar data of the European Remote Sensing satellites ERS-1 and ERS-2, but also high resolution optical data of Landsat, SPOT and IRS satellites are used. Different methods are applied to make use of the radar data. The analysis of the radar backscatter behaviour is primarily based on multitemporal intensity radar images of the agricultural fields, i.e. images taken in different time intervals during the vegetation period. Besides these interferometric methods applied to the radar data and resulting in products like coherence images, fringe images and relative-phase images can provide additional and complementary information to both radar intensity and optical intensity data. For that purpose ERS-1/ERS-2 image pairs with different acquisition times within the vegetation period are analysed with respect to their interferometric coherence, which depends on the biophysical change of the vegetation layer between the two acquisitions of an interferometric image pair. We prefer to apply the interferometric processing on ERS-1/ERS-2 Tandem image pairs. Because the time difference between the acquisition of these data is only 24 h the interferometric products (fringe image, relative phase image, coherence image) are of good quality. In the relative phase images we can identify topographic information but not for example height information due to different vegetation heights of the agricultural plants.

INS developed a program system for detection of agricultural land use with operational ERS-scenes as input. It is based on the PCI-image processing software EASI/PACE and the INS-radar interferometry software ANTIS and it consists of different data layers: geocoded GIS and remote sensing data / slant-range-radar-data / field-based-image-data / external database. A straightforward data exchange between the different data layers has been established and an operational data flow for preprocessing, coreferencing and geocoding of ERS data was realised. Central idea of the system is a field based data processing, because all data are related to the fields, i.e. the smallest area with unique agricultural fruits. We concentrate therefore on a few parameters described by the mean value and standard deviation of all pixels belonging to a field. The field based data allow to analyse, interpret, visualise and classify any kind of data stored within the system. Important prerequisite is the a-priori knowledge of field boundaries. In order to get the actual field boundaries, vector data from automated real estate register implemented in GIS were updated via GPS assistance or were deduced from remote sensing data, i.e. optical satellite imagery. The registration of field boundaries was also part of a ground truth program, where more than 1500 fields in seven test areas have been covered.

Conventional pixel based land use classification methods using Maximum Likelihood (ML) or Neural Net (NN) classifiers provide very poor classification accuracy, if only single frequency radar data with one polarisation component i.e. multitemporal ERS data are used as input. The field based methodology, applied on the same data can provide much better results, because calibrated radar backscatter values calculated from the mean value of all pixels of an agricultural field are almost independent from the typical speckle noise of the radar images. The field based land use classification is performed by simply applying standard ML or NN classifiers on the field based

image data. Also the selection of proper input channels and training fields is done with these data, whereas classification results can be transformed back into geocoded data.

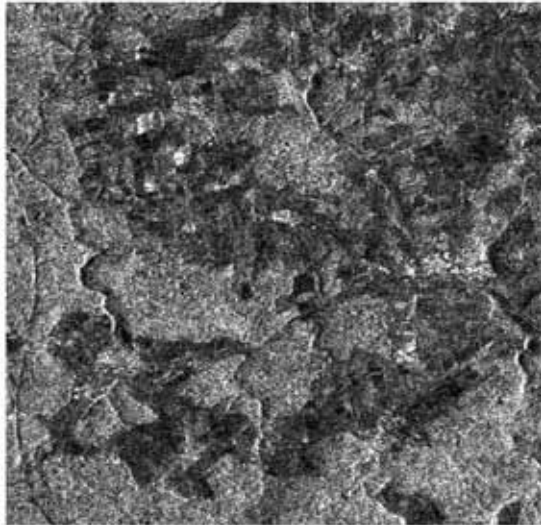

ERS-1 intensity image

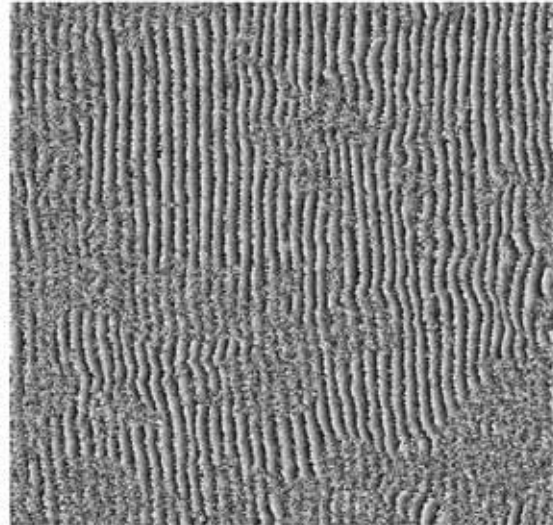

fringe image

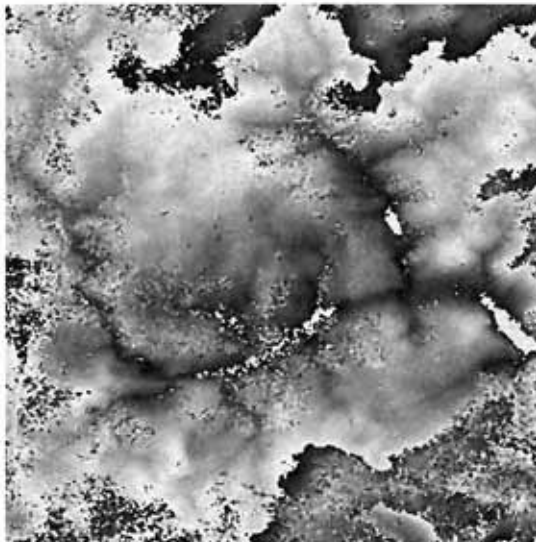

relative phase image

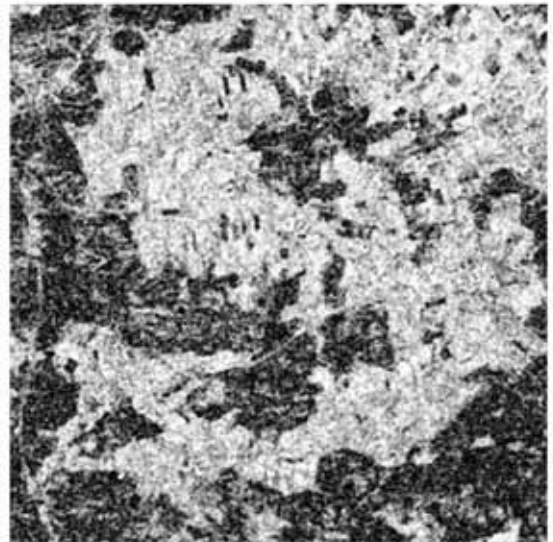

coherence image

Classifications have been performed by application of ML- and NN-classifiers on the field based data extracted from multitemporal ERS-1/ERS-2 intensity-channels, coherence information gained by interferometric processing of ERS-1/-2 images, and from additional optical images (SPOT and Landsat TM). The system was able to detect and separate the considered main land use classes, even if only ERS time series were used. It could be shown that the interferometric results support the monitoring of agricultural land use and farming activities and that the use of coherence information can improve the classification accuracy up to 6%. This is of special importance if no additional optical data and/or if only part of the multitemporal ERS-data are available, if for example first classification results are required at an early stage of the vegetation period. Although the results of classifications with only radar data are comparable to the accuracies achieved with multitemporal optical images the monofrequent ERS-radar data are not completely qualified for high accuracy (> 95%) classification applications. These can only be performed with multi frequency and multipolarisation radar systems, which up to date are not available as satellite systems. These systems are therefore the most important requisites for future satellite based radar systems.

## **Ice Shelf Studies in Antarctica using SAR Interferometry**

Remote sensing with ERS-SAR and especially Interferometric SAR (InSAR) e.g. used in Antarctica provides new insights to many phenomena, such as ice flow, topography, tidal movement of ice shelf, grounding line, etc. Of great interest are the ice shelf regions covering large coastal areas. The stability of these floating ice bodies, their mass balance, the energy exchange process and other factors have great influence on the cold water production for the oceans and on the global climate.

Synthetic aperture radar (SAR) data delivered by the European Remote Sensing Satellites ERS-1 and ERS-2 can be successfully used for interferometry. Traditionally, only the magnitude of the received signal was interpreted. Now, by means of SAR interferometry, the phase related to the distance between satellite and point of reflection of the radar signal on the earth proves to be a valuable source of information. The interferometric phase, i. e. the phase difference between two images acquired from slightly different sensor positions, contains geometrical information allowing the derivation of the three dimensional position of the scatter element.

The interferogram of an ice shelf region shows the well known difficulties of the superimposed effects of topography, vertical tidal and horizontal velocity movements. The complete separation of these effects for large areas is a challenging task and currently a part of our research activities. The cooperation of glaciological and interferometric experts provides an opportunity to address these difficulties, using interferometry and numerical simulation models.

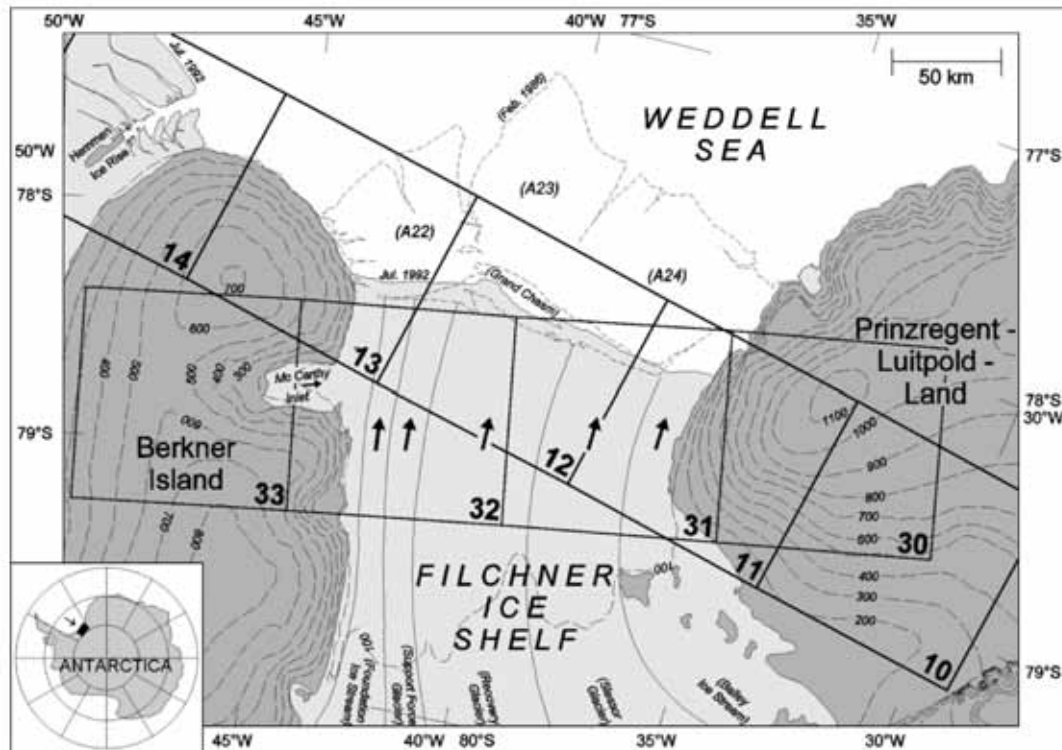

**Filchner Ice Shelf.** General topographic map of the northern part of Filchner Ice Shelf. The contour lines of ice surface elevation (in m a.s.l.) point to the considerably different surface reliefs of the flat ice shelf areas and the approximately dome-shaped ice covered regions. The ERS-1 SAR imagery used for this study covers the whole coastal zone of the Filchner Ice Shelf (locations of SAR images are indicated by rectangles).

### **Mapping of ecosystem referred long term trends in deposition loads and concentration of air pollutants in Germany and their comparison with Critical Loads**

The research project „Mapping of ecosystem referred long term trends in deposition loads and concentration of air pollutants in Germany and their comparison with Critical Loads and Critical Levels“ (BMU/UBA FE-NO. 299 42 210) is funded by Federal Environmental Agency (UBA).

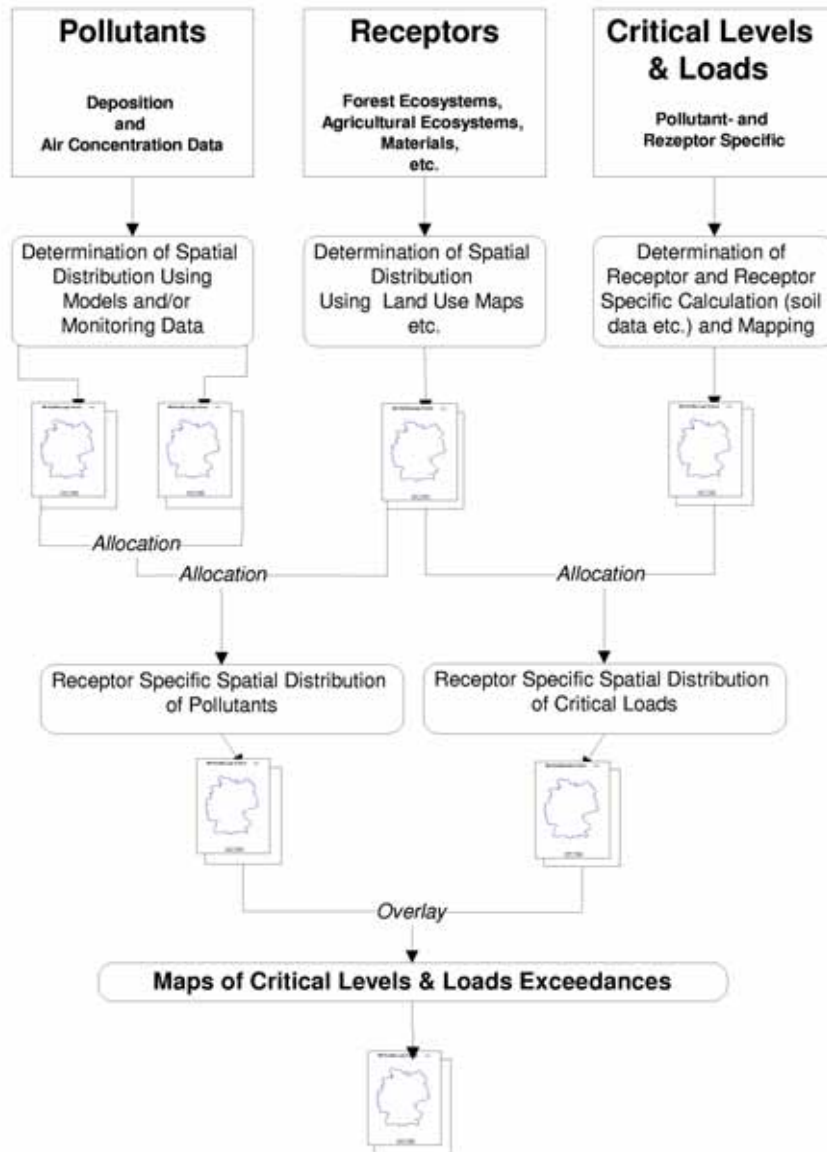

The aim of the project is to support the German Federal Environmental Agency in calculation and verification of national data to be implemented in European scale Critical Loads and Levels maps. Special interest is put on the detection of long term trends in deposition loads and concentration of air pollutants in Germany. The results of this research project are gained by working in close cooperation with „Gesellschaft für Ökosystemanalyse und Umweltdatenmanagement mbH“ (ÖKO-DATA GmbH) located in Strausberg, Netherlands Organization for Applied Scientific Research (TNO), Appeldoorn, The Netherlands and Netherlands Energy Research Foundation (ECN), Petten, The Netherlands.

**The Critical Loads and Levels** concept was adopted as a policy making tool in development of emission control strategies within the United Nations Convention on Long Range Transboundary Air Pollution (signed in 1979). **Critical Levels** are defined as concentrations of pollutants in the atmosphere above which direct adverse effects on receptors, such as human beings, plants, ecosystems or materials, may occur according to present knowledge.

**Critical Load** a quantitative estimate of an exposure to one or more pollutants below which significant harmful effects on specified sensitive elements of the environment do not occur according to present knowledge.

Within the project national maps of concentration levels and deposition loads are generated. Maps of deposition loads are used to calculate Critical Loads exceedances in Germany. The calculation of the maps is based upon measurement network data, additional model estimates and high resolution land use maps. Differences of yearly air pollutant input to several ecosystems on the local scale can be identified and exceedances of Critical Levels and Critical Loads within different regions in Germany can be determined.

To manage the complex tasks within mapping Critical Levels & Loads in Germany the efficient use of Geographical Information Systems (GIS) is indispensable. ARC/INFO is used to handle the big amount of air pollutant data and to calculate the high resolution (1x1 km<sup>2</sup>) output maps on the national scale.

## Publications 2000

- Dettmering, D. (2000): Berichte zur XXII. Generalversammlung der IUGG, Symposium JSG28: Probing the Atmosphere by GPS, ZfV 7/2000, Wittwer, Stuttgart, Juli 2000
- Wehr, A. (2000): Laserscanner in der Bauaufnahme, Proceedings „Von Handaufmaß bis High
- Gauger, Th., Köble, R.. & Anshelm, F. (2000): Endbericht zum Forschungsvorhaben FKZ 108 03 079 „Kritische Luftschadstoff-Konzentrationen und Eintragsraten sowie ihre Überschreitung für Wald- und Agrarökosysteme sowie naturnahe waldfreie Ökosysteme“. Im Auftrag des Umweltbundesamtes.
- Ueno, M., Santerre R. & Kleusberg A. (2000): Direct Determination of Angular Velocity Using GPS. Navigation (UK) 53 (2), pp. 371-379

## Presentations:

- Dettmering, D. (2000): Die Nutzung von GPS-Signalen zur dreidimensionalen Ionosphärenmodellierung, Geodätische Woche '00, 10-12 Oktober 2000, GeoForschungsZentrum, Potsdam
- Reich, M. (2000): EMAP-Landnutzungsinventur mit Hilfe der ERS-1/2-RADAR-Fernerkundung, Forschungsvorhaben EMAP, beim Bundesministerium für Ernährung, Landwirtschaft und Forsten, Referat 525 - Nachhaltige Entwicklung
- Anshelm, F. (2000): Mapping Actual Corrosion Rates and exceedances of Acceptable Corrosion Rates in Germany.- UN ECE Workshop on Mapping Air Pollution Effects on Materials including Stock at Risk; 14-16 June 2000, Stockholm, Sweden.
- Gauger, Th. (2000): Air Pollutants in Germany: Long Term Trends in Deposition and Air Concentration.- UN ECE Workshop on Mapping Air Pollution Effects on Materials including Stock at Risk; 14-16 June 2000, Stockholm, Sweden.

## Diploma Theses

Pfister, Charlotte (2000): Validierung der GPS/Glonass-Referenzstation in Frankfurt

## Activities in National and International Organizations

Alfred Kleusberg:

- Fellow of the International Association of the Geodesy
- Member of the Royal Institute of Navigation
- Member of the German Institute of Navigation
- Adjunct Professor, University of New Brunswick, Canada
- Adjunct Professor, University of Main, USA
- Adjunct Professor, Laval University, Canada

## Education (Lecture / Practice / Training / Seminar)

Introduction to Navigation (Kleusberg)	2/0/0/0
Flight Navigation und Avionic (Schöller, Wehr)	2/0/0/0
Introduction to Electronics for Geodesists (Wehr)	2/1/0/0
Electronics for Geodesists (Wehr)	2/1/0/0
Remote Sensing I (Thiel)	1/1/0/0
Remote Sensing II (Smiatek)	1/1/0/0
Navigation I, II (Kleusberg)	3/1/0/0
Navigation III / Radartechniques (Braun)	2/1/0/0
Electrical Engineering for Geodesists (Schöller)	3/1/0/0
Practical Course in Navigation (Schöller)	0/0/2/0
Practical Course in Electrical Engineering (Wehr, Selig)	0/0/2/0
Practical Course in Electronics (Wehr, Selig)	0/0/4/0
Applied Kalman Filtering (Schöller)	2/0/0/0
Software Development (Fritsch, Grafarend, Keller, Kleusberg, Möhlenbrink)	0/0/4/0
Geodetic Seminar I, II (Fritsch, Grafarend, Keller, Kleusberg, Möhlenbrink)	0/0/0/4
Satellite Systems and Programming in Remote Sensing (Liebig)	2/0/0/0





## Institute for Photogrammetry

Geschwister-Scholl-Str. 24/D, D-70174 Stuttgart,  
Tel.: +49 711 121 3386, Fax: +49 711 121 3297  
e-mail: [firstname.secondname@ifp.uni-stuttgart.de](mailto:firstname.secondname@ifp.uni-stuttgart.de)  
url: <http://www.ifp.uni-stuttgart.de>

### Head of Institute

Prof. Dr.-Ing. Dieter Fritsch  
Deputy: Dr.-Ing. Norbert Haala  
Secretary: Martina Kroma

Emeritus: Prof. i.R. Dr. mult. Fritz Ackermann  
Bureau of Continuing Education: Dorothee Klink

### Working Groups at the ifp:

#### Photogrammetry and Remote Sensing

Head: Dr.-Ing. Norbert Haala  
Dipl.-Ing.(FH) Werner Schneider  
Dipl.-Phys. Heiner Hild  
Dr.-Ing. Babak Ameri

Multisensor Photogrammetry  
Digital Photogrammetry Lab  
Automatic Image to Map Registration  
Building Reconstruction

#### Geographic Information Systems

Head: Dr.-Ing. Monika Sester  
Dipl.-Ing. Michael Glemser  
Dr.-Ing. Ulrike Klein  
Dipl.-Ing. Thomas Schürle  
Dr.-Ing. Volker Walter  
Dipl.-Geogr. Steffen Volz

Multi-scale Representation  
Data Quality in GIS  
Data Quality in Hybrid GIS  
Facility Management Systems  
GIS and Remote Sensing  
Spatially Aware Information Systems

#### Optical Inspection

Head: Dr.-Ing. Claus Brenner  
Dipl.-Inform. Jan Böhm  
Dipl.-Ing. Jens Gührung  
Dipl.-Ing. Jürgen Hefe

Modeling and Object Recognition  
Spatial Segmentation and Object Recognition  
Sensor Calibration and Spatial Segmentation  
Optical Inspection

## Sensor Integration

Head: Dr.-Ing. Michael Cramer  
Dipl.-Ing.(FH) Markus English  
Dipl.-Ing. Dirk Stallmann  
Dipl.-Ing. Darko Klinec

GPS/INS-Integration  
Sensor Laboratory  
Aerial Triangulation  
Pedestrian Navigation

## External PhD Students

Dipl.-Ing. Marianne Wind  
Dipl.-Math. Wolfgang Schmid

Automatic DTM Generation  
GIS Shortest Path Analysis

## External teaching staff

Dipl.-Ing. Volker Schäfer, Ltd. Verm. Dir., Wirtschaftsministerium Baden-Württemberg  
Dr.-jur. F. Schwantag, Reg. Dir., Landesamt für Flurordnung und  
Landesentwicklung Baden-Württemberg

## Notable Events at ifp

The most important event in 2000 was the election of Dieter Fritsch as rector of the University of Stuttgart for a period of six years. Inauguration Day was October 24, 2000. Beside this full-time job he still is head of the Institute for Photogrammetry.

# Research Projects

## Photogrammetry and Remote Sensing

### Sustainable Development for Integrated Landuse Planning

The joint German-Chinese research project SILUP aims at developing and implementing a strategy for sustainable land use planning in a rapidly developing study area south of Nanjing, Jiangsu province, China. Nanjing is located at the Jiangtse river, about 300km west of Shanghai. Because of the rapid development of the site there is a high pressure for land to be transferred from agricultural use into built up use. Sustainable development in this context means simultaneously respecting the ecological and socio-economical value of land, judging it and finding the best suited areas to fulfill the demands. For the ecological side, water management aspects as well as

biodiversity and soil aspects are of importance. Areas with important functions for groundwater recharge, surface water runoff, biotopes and the like have to be identified and protected from land use change. The desired output of the SILUP system is a categorized map which shows land use planners, where agriculturally used areas can be a target for further development. For the decision steps, the variety of possible input data will be fused in a hierarchical matrix decision tree leading to a final classification matrix (FCM) which combines socio-economic and ecological value of land and assigns a certain transferability class between „absolutely protected“ and „well suited“ to each spatial unit.

The project team consists of a hydraulic modeling group, a socio-economic group, an ecology group and a GIS / Remote Sensing group. For each group there is an institute from Stuttgart University and one or two from Nanjing. The role of ifp is - together with the GIS group of Nanjing University - to provide the required spatial database, which consists of the layers representing transportation network, surface water, elevation data (DEM, aspect map, slope map), administrative units, settlement centers, planning related information, orthoimages. Most of this information was extracted from SPOT PAN and multispectral data; overall two georeferenced panchromatic and two georeferenced multispectral scenes were available for the project. Based on the multispectral data, multispectral classification was carried out in a combined unsupervised-supervised hierarchical strategy in order to obtain actual land cover information. Together with topographic data, which was updated manually from the panchromatic scenes, a vector land use map was created (see below).

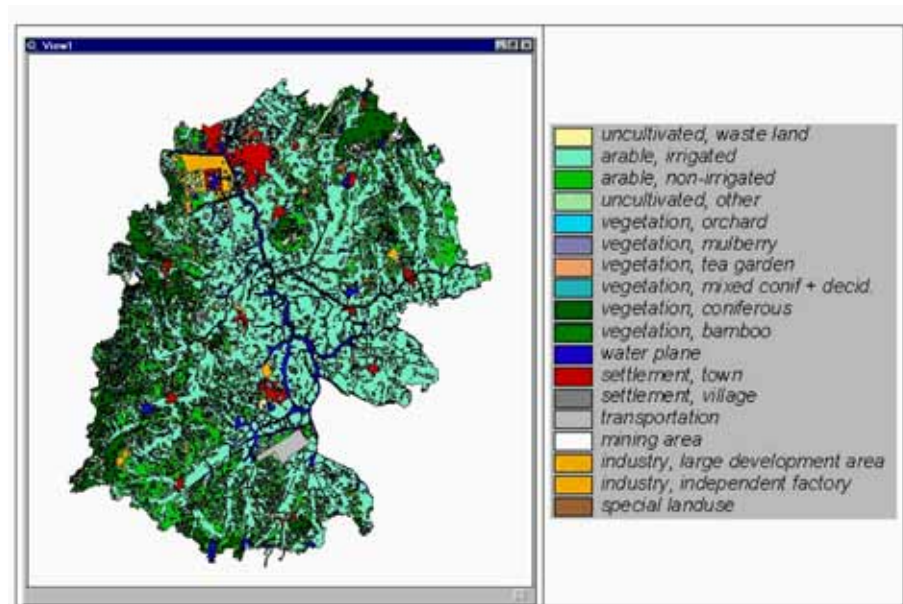

Based on existing elevation information as well as the linear river network and polder areas from the extensive irrigation system a constrained DEM was generated. In this DEM all rivers have the correct flow direction and all water bodies are leveled flat. These constraints are especially required in the irrigated regions since there is almost no terrain undulation in these areas, which makes flow direction calculation rather difficult. The following picture shows the collected DEM with overlaid orthoimage, surface water system (line rivers, area water bodies and polder areas) and the road network, which was updated manually from the topographic map and the georeferenced panchromatic SPOT scene.

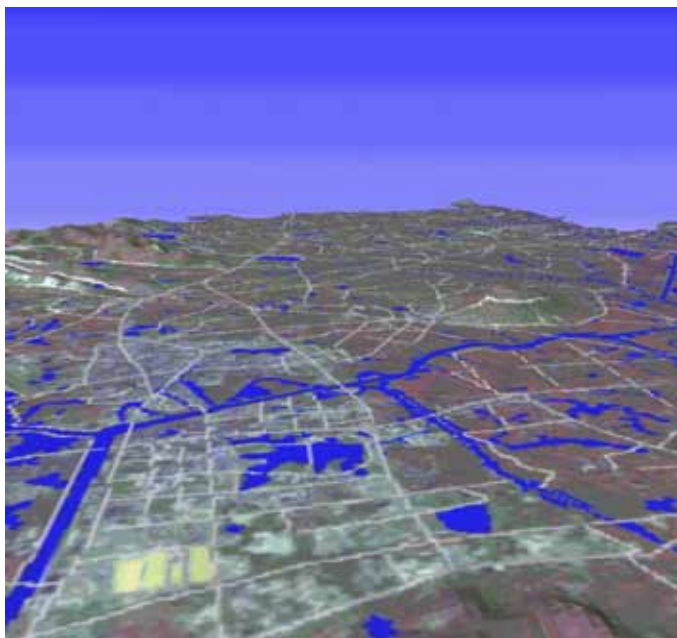

### **Automatic Image to Map Registration**

The approach developed in this project aims on the fully automatic georeferencing of images without any a priori information on the exterior orientation. Thus for georeferencing, objects extracted from the image are matched against corresponding objects provided by an existing GIS data base. For current tests SPOT imagery and ATKIS data are used. An overview of the proposed system is depicted in the figure below. As it is visible, the algorithm can be divided in three main parts. The phases I and II are separated into the parts object generation (OG), feature extraction (FE), matching and verification (MV). Phase I aims on the determination of a global affine transformation between the SPOT imagery and the ATKIS data in order to provide a first approximation on image scale and orientation. All corresponding image and GIS objects are used

to determine these parameters. For aerial photography the main problem during the application of a global affine transformation between object and image space is relief, whereas for satellite imagery like is applied in this study, problems will mainly occur for large tilt angles. Nevertheless, since the global affine transformation is only applied to provide approximate values for the subsequent steps, it was found to be sufficient for our goals. Since the great influence of the selected thresholds on the results of the image segmentation processes is well known, the basic philosophy of the algorithm is to replace the search for an 'optimal' set of parameters by an iterative process in order to apply a number of different thresholds, automatically. This of course results in a large number of segmentation results. Hence, due to the large number of potential matches between GIS and image objects, the computational effort for the feature extraction and the subsequent matching process has to be optimized. This is realized by a feature based matching procedure. The generated matching hypotheses are verified by a robust estimation of a global affine transformation between the corresponding objects. In phase II this global transformation is refined using the parameters defined in phase I to provide approximate values for a re-segmentation of image objects. For this purpose, the GIS objects are mapped into the image applying the coarse affine transformation of phase I. The GIS objects then provide seed regions, which are applied in phase II for a refined segmentation. Based on this segmentation the matching procedure is repeated, subsequently. This results in an improved, but still global affine transformation. In phase III, individual affine transformations between corresponding objects are computed. This is realized by an iterative closest point algorithm based on the boundaries, which results in single ground control points to be used for a subsequent aerial triangulation.

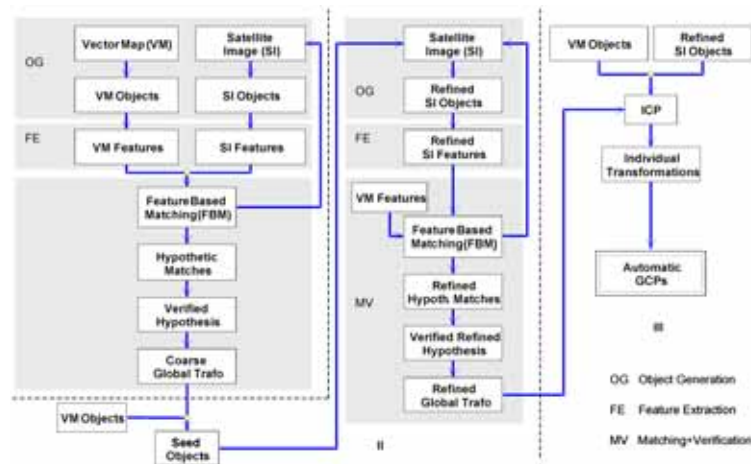

Dataflow of the proposed system

## Virtual City Models

Two systems have been developed for the 3D reconstruction of built-up areas. One approach aims at a fully automatic, data driven reconstruction of generic plane-face building objects from digital airborne imagery through the integration of computer vision and digital photogrammetric techniques. Similar to comparable approaches, good results can be achieved by this algorithm for the reconstruction of sub-urban areas. For the 3D reconstruction of very complex urban scenes an alternative system is available, which is based on the use of height data from airborne laser scanning and the ground plans of buildings provided by an existing 2D GIS or map data. Since the 3D reconstruction is based on an existing GIS, also information on usage, owner etc. can easily be linked to the reconstructed buildings. By this system a virtual city model of Stuttgart covering more than 5000 buildings has been generated, which is currently used as input data for the projects NEXUS and GISMO. In a final step of model generation, aerial or terrestrial images are mapped against the faces of the reconstructed buildings to provide photo texture for realistic visualization. If the exterior orientation of the used imagery is available, this process can be run automatically. Since standard procedures for the automatic reconstruction of exterior orientation are only available for aerial images, current research also aims at the use of already reconstructed 3D building models for the orientation of terrestrial imagery.

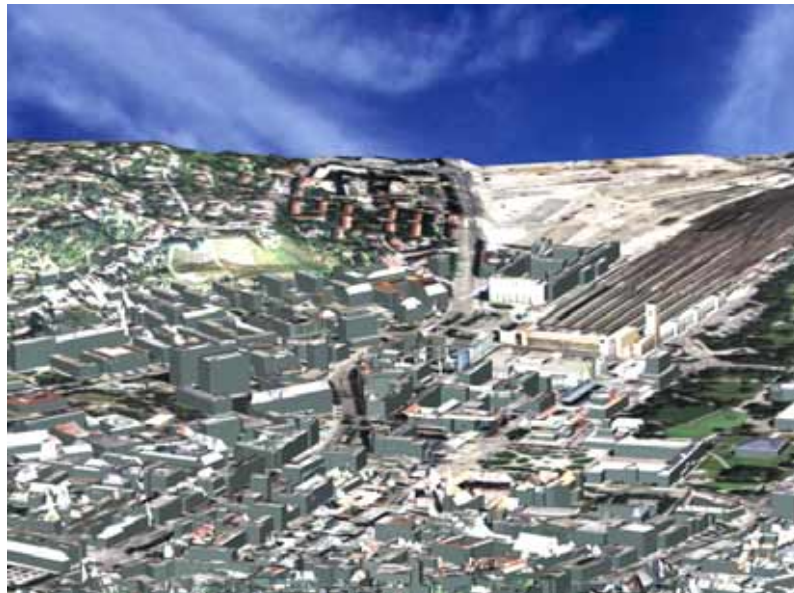

*Virtual landscape model of the city of Stuttgart seen from a bird's eye view.*

## Digital Photogrammetric Laboratory

The digital photogrammetry and remote sensing group is cooperating very closely with a number of companies and institutions for the development of a new generation of digital airborne and space borne photogrammetric systems. In addition to the availability of the required software and hardware (photogrammetric workstations, scanner, own software developments) in the digital photogrammetric laboratory, a test site close to Stuttgart has been established and is maintained by the ifp (test site Vaihingen/Enz). Within this test site a large number of well defined signalized points are available which are regularly used for accuracy tests of commercial systems like digital airborne cameras, integrated systems for direct geo-referencing or airborne laser scanners.

## Geographic Information Systems

### Analysis and Implementation of a Method for Location Referencing

When information of locations in the real world is exchanged between transport telematics applications, there is a significant likelihood that the different systems will use different map databases. Under present systems exchange of location information is done by cross-referencing methods. In these methods selected locations are pre-coded with codes that are interpretable by associated location tables (e.g. RDS/TMC).

However, for detailed location referencing, it must be possible to reference all road sections that exist in Europe. It is not practical to do this by pre-coding; it would require a master database, whose creation and maintenance costs would be prohibitive.

The ERTICO Committee on Location Referencing developed in the project EVIDENCE a new universal method for location referencing that does not require any pre-coding of locations. A key characteristic of the method is the on-the fly coding approach: a code is created when needed by a system A that sends the information, is then interpreted and used by a receiving system B, and finally is discarded. The following figure shows the strategy of the method.

The coding basis of the method is the Intersection LOcation (ILOC), defined where two or more roads meet. The ILOC code consists of three independent parts. The first part contains WGS84 coordinates of the coded ILOC. Then it follows a part with three descriptors, which are build from road attributes like street names or street numbers. The last part deviates from the original ILOC method and represents the number of roads connected to the ILOC.

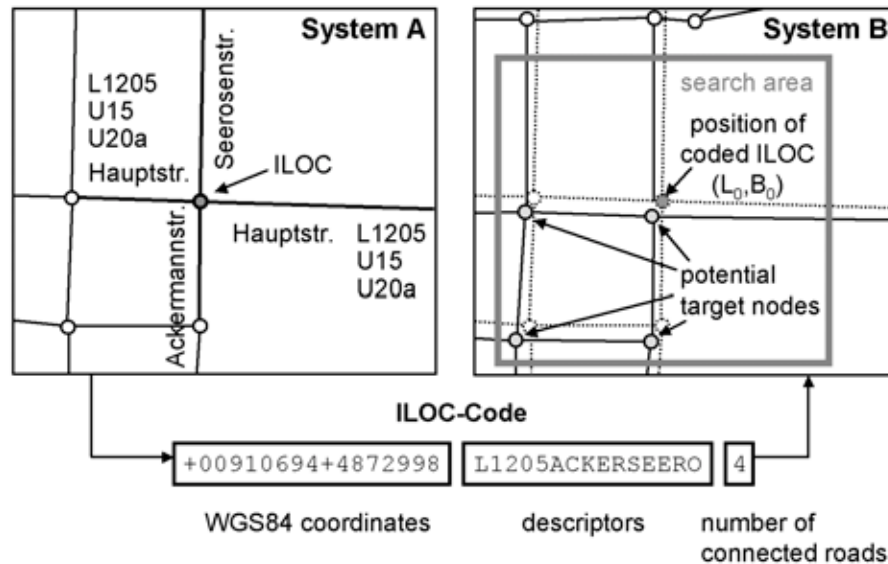

After the code is received by system B, the position  $(L_0, B_0)$  of the coded ILOC is extracted and a search area is created around  $(L_0, B_0)$ . For all ILOC's within the search area (potential target nodes) ILOC codes are generated and compared with the received code. The ILOC with the most similar code is the appropriate ILOC. Rules for creating and comparing the descriptor part have to be established.

The method had been implemented in the programming language C++ and tests within three test areas were realized. The databases used in the tests represented the road network in the GDF Level 1, coding level in EVIDENCE was the less detailed GDF Level 2. In residential areas the success rate for the automatic assignment of ILOC's is up to 95%, while the success rate in the center of Stuttgart is only 85%. That's because of the higher amount of complex crossings and parallel roads. In these areas the method is not robust enough and the assignment often fails if attributes in both databases deviate. An possible approach to improve the method is to increase the number of street attributes transmitted by the code. But the method will always depend on correct databases. The coding of road sections instead of intersections could improve the success rate.



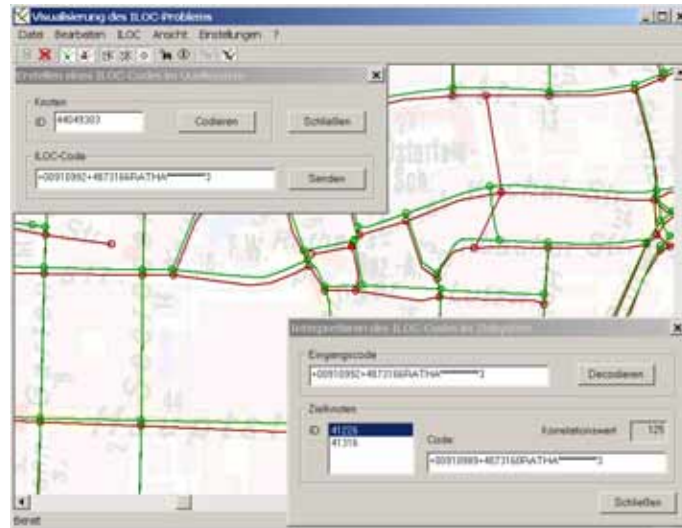

*Developed software system*

### **GISMO: Real-time Visualization of Virtual 3-D Landscapes**

The automated acquisition and construction of realistic, three-dimensional models of our environment has quickly advanced in recent years. New photogrammetric techniques have been developed, which not only make detailed terrain data available, but also allow the recognition and reconstruction of buildings. Large datasets of vector and raster data have now been collected and stored as virtual landscape models by different organisations and institutions. These models store both the geometry and phototextures made from aerial and terrestrial images and easily exceed data volumes of many gigabytes. Special graphics hard- and software is thus needed so far for their real-time visualization.

The goal of the GISMO project is to build a new software system that is capable of rendering such large-scale models on conventional computer hardware. Especially urban models, like the city of Stuttgart, are of main interest. One major focus will be the integration of the GISMO system into navigational systems, spatially aware applications, multi-media applications and simulations. To support this wide area of application, the scalability to different hardware platforms is planned. The above-mentioned applications are also constituted of different classes of landscape visualization problems in terms of the viewing position relative to the model. In the end, GISMO will allow users to have strategic overviews of the virtual city models, experience flights over their highly detailed landscapes and even walkthroughs to visit places, streets and the interior of buildings as a virtual tourist.



*Stuttgart main station showing photo realistic textures.*

During the development of the GISMO system two basic strategies are pursued. The complexity of the models is reduced with the help of generalization techniques so that models with varying details can be generated. This process is essential to shorten the rendering time of scenes and to make the overall look of the landscape models visually more appealing on different kinds of computer displays. This so-called level of detail technique can also be used to show a section of a model with varying details depending on the viewer's position and orientation. The second strategy is to evaluate existing graphics algorithms and visualization techniques with regard to their usability in the GISMO system. In the following, examples of some promising methods are mentioned, which have already been shown to be highly effective in similar applications like GISMO:

- ▷ Culling techniques are able to identify parts of the model from spatially organized data structures that are not visible to the viewer and therefore are in no need to be rendered (e.g. bounding boxes, occlusion culling).
- ▷ Image based rendering techniques model object details by not using geometry, but rather by the use of textures (e.g. bump mapping, impostors).
- ▷ Volume rendering techniques are able to visualize effects like fog, smoke and clouds (e.g. raycasting, splatting).

The combination of the above mentioned strategies and techniques, in conjunction with an efficient implementation of the system allows the visualization of such complex datasets found in virtual city models.

## Sensor integration

### Real-time positioning for location aware applications using multi-sensor configurations and mobile photogrammetry

The research project „NEXUS“<sup>1</sup> aims at the development of a generic platform that supports location aware applications with mobile users. Within NEXUS the world is represented by spatial models, describing the real world and additional virtual objects the real world is augmented with. The virtual objects act as brokers between the platform and external information sources and services. Interactions between the mobile users and the virtual or real world objects are realized using the actual location resp. position information. The general platform concept is depicted in the following figure.

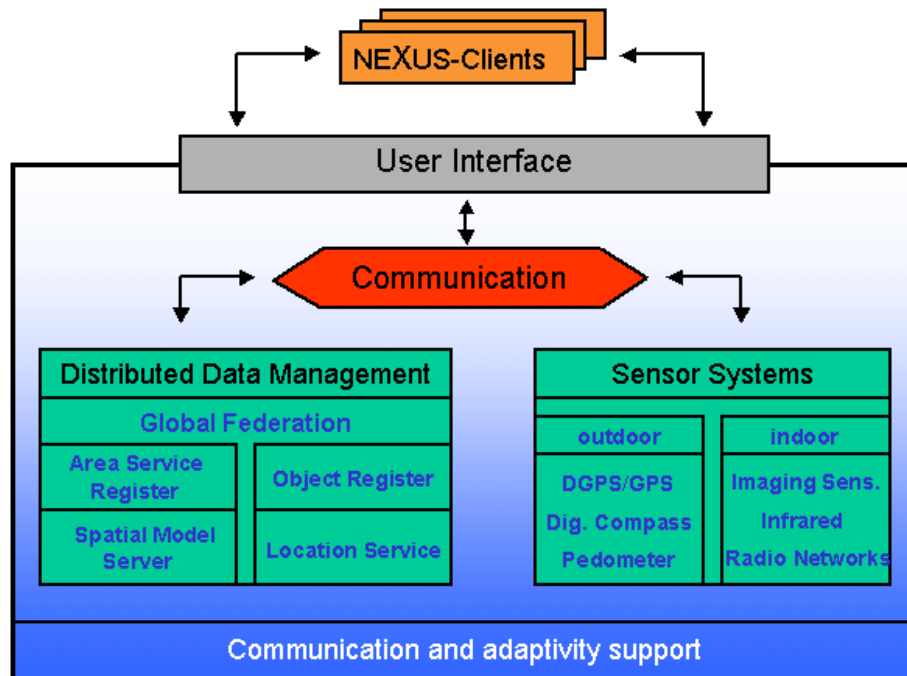

*The general NEXUS platform architecture.*

<sup>1</sup>The project is under current investigation within a so-called research group supported by the DFG (German Research Council) in cooperation with the Institute for Photogrammetry (ifp), the Institute of Parallel and Distributed High-Performance Systems and the Institute of Communication Networks and Computer Engineering at University of Stuttgart.

As soon as the actual position of the user is known access to real-life and virtual objects is possible. Virtual objects are non visible for human eyes but they exist in the model and have an area of visibility and a fixed position. If a NEXUS user enters the area of visibility, information of the virtual object is accessible. Contrary to this, real-life objects (e.g. buildings) do not have such areas of visibility and access to information has to be provided in a different way. Thus one main problem of the platform architecture is the need for accurate and real-time position information to provide location awareness. The main application areas of NEXUS are urban areas where pedestrians will access location aware information using small devices like PDAs (Personal Digital Assistant) in outdoor as well as in indoor areas. To determine the actual position of mobile users in such different environments, the use of multi-sensor configurations combining different positioning techniques like GPS, compass and mobile photogrammetry is inevitable. In outdoor applications the positioning is mainly based on DGPS receivers that will be integrated in PDAs in future. Due to the inherent satellite masking problems in urban canyons the GPS positioning is supported by additional sensors like pedometer and compass. For indoor applications the use of GPS fails, but mobile photogrammetry gives an alternative to solve the positioning task. Using a small digital camera and image processing techniques the system is able to determine the actual (indoor) position of the mobile user on the one hand and on the other hand the location of objects detected in the digital imagery. To access certain distinct objects like works of art in a gallery a telepointing device as one part of the NEXUS system is used. By pointing the object is located using the spatial model of the world and the computed telepointing parameters. Once the location of the object is determined any available information on the object is provided.

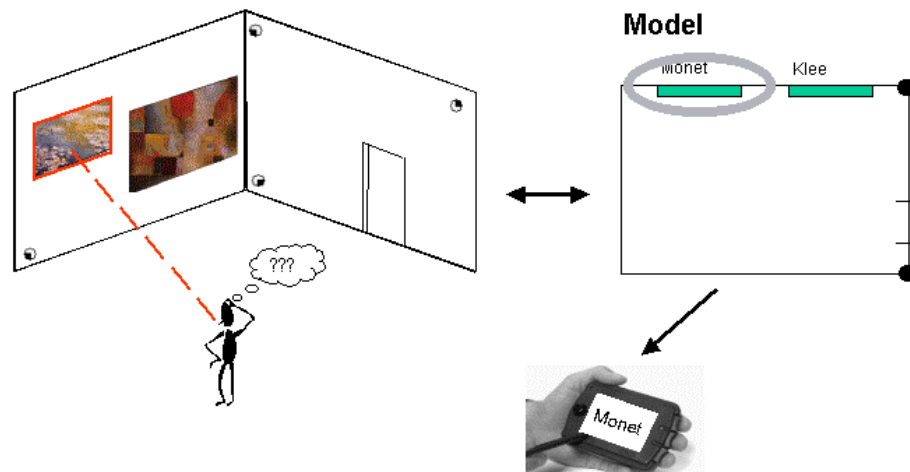

*Principle of telepointing functionality.*

## On the use of direct georeferencing in airborne photogrammetry

With the availability of high-end integrated GPS/inertial systems the direct georeferencing of airborne imaging sensors becomes feasible even for highest accuracy demands. Such integrated systems provide the only way for an efficient orientation of the upcoming airborne digital line scanning sensors. Nevertheless, the use of GPS/inertial systems in combination with classical analogue aerial cameras is advantageous, too. Over the last years our work was focused on the investigation on the performance of direct orientation measurements in airborne photogrammetric environments. Extensive flight tests were done in 1998 and 2000 utilizing the test site Vaihingen/Enz. This test consists of up to 100 signalized and co-ordinated ground control points that are used for the independent accuracy investigations. Especially two commercially available integrated high-end GPS/inertial systems (Applanix POS/AV 510 DG, IGI AEROcontrol II d) in combination with standard analogue aerial cameras (Z/I Imaging RMK-Top15) were tested extensively. The corresponding flight trajectories are depicted in the figures below. Since both systems were flown in the same test area under quasi-operational and very similar flight conditions the results can be compared directly. For the final accuracy test not only the quality of GPS/inertial orientations but the image block geometry - resulting in varying image overlaps - and the quality and stability of the imaging sensor is of major concern.

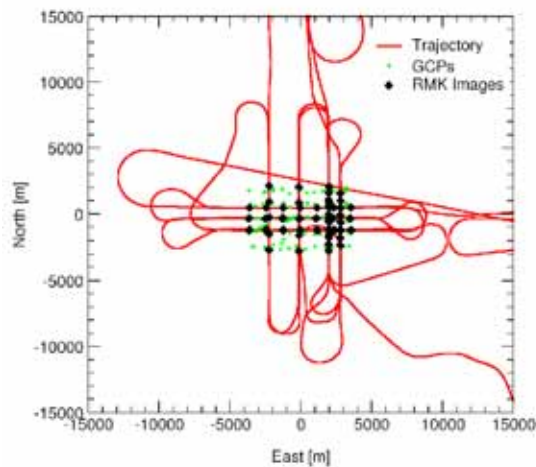

*Applanix POS/AV 510 DG test flight Vaihingen/Enz (December 17, 1998).*

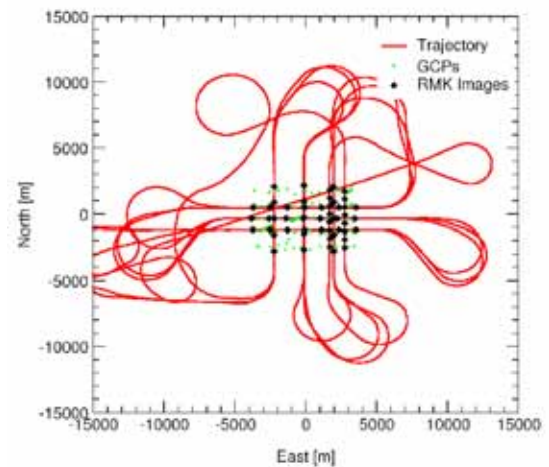

*IGI AEROcontrol II d test flight Vaihingen/Enz (June 9, 2000).*

The empirical tests have shown that direct georeferencing of standard analogue photogrammetric cameras using commercial high-end integrated GPS/inertial systems provides an accuracy (RMS) of 1-2dm for the horizontal components and 2-3dm for the vertical coordinate in operational airborne environments. This accuracy is obtained without any ground control. The obtained results are representative and should be reproducible for later use in a production environment. The accuracy values mentioned above are valid even for the evaluation of single flight lines, which are somehow critical from standard photogrammetric point of data processing. Transferring the obtained accuracy to accuracy values traditionally used in photogrammetry, the horizontal accuracy corresponds to  $10\mu\text{m}$  in image space and the vertical accuracy is about 0.01% of the flying height assuming an image scale of 1:13000 and a corresponding flying height of 2000m above ground. Although this accuracy is about a factor of two worse compared to the accuracy theoretically obtained in photogrammetric aerial triangulation, this performance is sufficient for almost all of the future applications in photogrammetry, in particular on the background of the new digital airborne sensors with their multi-spectral data acquisition capability for airborne remote sensing applications. Thus, the direct method of image orientation will provide significant advantages with respect to very high flexibility and fast and efficient data evaluation. From this point, direct georeferencing based on high quality integrated GPS/inertial systems will gain in importance and become the standard approach for the orientation of digital imagery, at least for the remote sensing applications.

## **Rigorous photogrammetric processing of high resolution satellite imagery**

Past and current satellite based optical sensors like SPOT, IRS-1C/1D and MOMS-02 use linear arrays in pushbroom mode. These systems provide panchromatic and multispectral image acquisition with a geometric resolution between 5m and 20m ground sampling distance. Stereographic coverage is provided by along-track (MOMS-02) or across-track (SPOT) image data collection. New and future systems like IKONOS-2 and QuickBird will have improved features, especially an higher geometric resolution, up to 1m in panchromatic and 4m in multispectral mode with a better dynamic radiometric range. In addition high precision orbital position and attitude data will be provided by the on-board Global Positioning System (GPS) receivers, Inertial Measurement Units (IMU) and star trackers. This additional information allows a significant reduction of ground control. In the ideal case, this information enables direct georeferencing of the imagery without geometric reconstruction of the imaging process (photogrammetric triangulation) and ground control. These developments offer new possibilities for the derivation of follow-ups like digital surface/terrain models, orthoimages and classification maps. Nevertheless the scenario is quite similar to the airborne environment: to provide accurate and reliable products the calibration and verification of the whole sensor system, consisting of the imaging (camera) part and the position and attitude components, is necessary. For this task an extended bundle adjustment for reconstruction of the exterior orientation and point determination with self-calibration for satellite imagery was developed.

The used geometric model is based on an extension of a SPOT model realized by V. Kratky. This geometric solution combines the principle of rigorous photogrammetric bundle formulation with additional constraints assuming an elliptic satellite orbit. The sensor position is derived from known nominal orbit relations, while the attitude variations are modelled by a simple polynomial model (linear or quadratic). For self-calibration two additional parameters are added: the focal length (camera constant) and the principle point correction. The exterior orientation and the additional parameters of the sensor model are determined in a general formulation of the least-squares adjustment (Gauss-Helmert model). The use of additional information, e.g. from supplemented data files is not mandatory, but if this information is available it can be used to approximate or preset some of the unknown parameters.

For the accuracy evaluation three MOMS-02/P data takes from three different orbits over Southern Germany were available. These data takes were acquired on March 14, 1997, May 8, 1998 and June 25, 1998. The processing level of all three data takes was level 1A, i.e. "raw" panchromatic image data without corrections except for the radiometric improvement and a ground sample distance of 18m. The image quality of all three takes was good. The radiometric resolution was about 7 bits. A strong radiometric preprocessing was not necessary. Only linear brightness and contrast enhancement was applied. Using the implemented approach based on Kratky's simple, fast but strict sensor model an accuracy of 11-14m in planimetry and 13m in height was achieved. Only ca. 10 GCPs are required for the orientation of a stereo pair. The reached accuracy of point determination is acceptable for most applications, e.g.: DTM/DSM generation, ortho image generation, topographic mapping.



*Airport Munich in MOMS-02/P data take T083FE (June 25, 1998).*

## Optical Inspection

### Machine Vision

In order to perform a measurement of a specific feature of an object such as a drill hole, we have to extract the feature from the sensor data. Furthermore we have to bring it up to a level of abstraction comparable to that of a CAD model, which holds the specification, so that we can evaluate the measurement properly. We incorporate model based segmentation strategies and object recognition technologies to achieve this.

We have implemented some of the most common operations for 2-D image processing to carry out some tests of our system. They can best be described using a practical example. The task is to locate an engine block within the measurement volume and to precisely recover its pose with respect to its internal coordinate system specified by the CAD model. The first image is taken with the wide angle zoom lens camera. We use an adaptive threshold technique to separate the object from the background. We then compute the minimal enclosing rectangle (MER) to estimate the pose of the engine block.

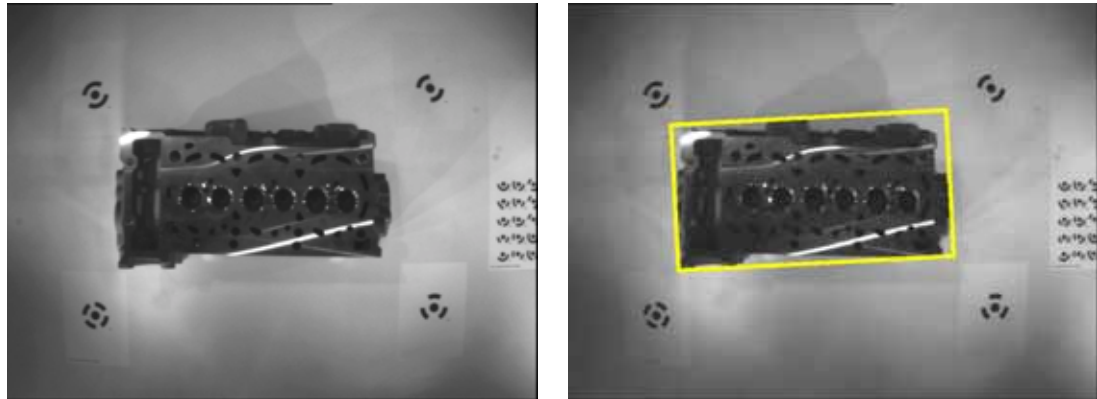

*Coarse object localization.*

From the CAD model the openings of the valve seatings were manually selected as reference features. The origin of the CAD model's coordinate system is located in-between the centers of the two outmost valves.

With the high-resolution stereo camera we take the next images of the combustion chambers machined surface. Because of the proper lighting conditions we achieve with the controllable lights the valve openings separate from the plane and these can easily be segmented. The proper valves are approximated by ellipses and the center is precisely measured. With the parameters of



the stereo camera obtained during calibration we can compute the forward intersection providing us with the 3-D coordinates of the points. The two points define the origin and a direction of the coordinate system. This example demonstrates well our approach to optical measurement using a coarse-to-fine strategy and is an excellent example of how different sensors can be combined to perform a measurement task.

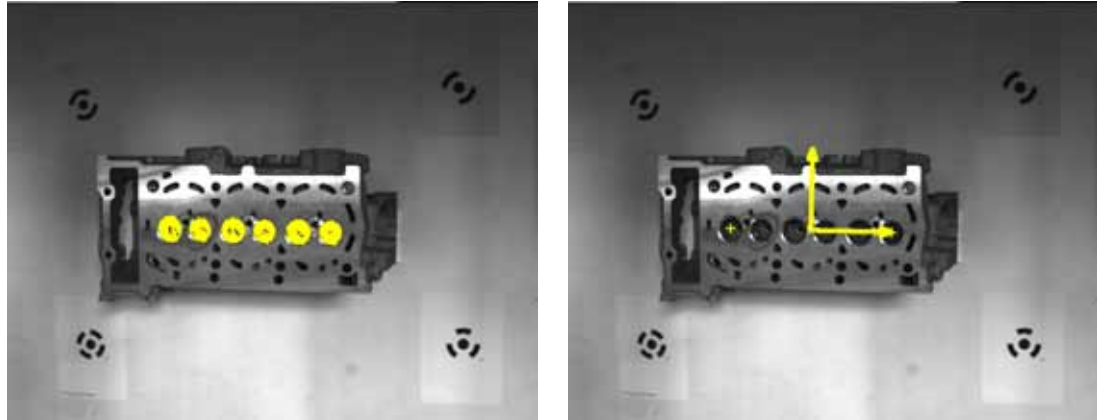

*Retrieving the objects internal coordinate system.*

### **Optical 3D shape acquisition**

Optical 3D shape acquisition systems provide fast and dense surface measurements without the need for physically probing surfaces, thus making them ideally suited for various applications in industrial inspection and reverse engineering. However, industry acceptance does not adequately reflect the theoretical and practical performance of these systems. One reason for the slow industry acceptance is measurement uncertainty, which is not constant over the measurement volume. It rather depends on a number of factors like sensor hardware, sensing geometry and the shape and reflectance properties of the object under consideration. Inspection results usually require a number of further processing steps. Thus, the achieved accuracy is hard to estimate, even for experienced operators. We have developed a complete processing chain for industrial part inspection that provides the user not only with the geometric difference between the measured object and its CAD model, but also with the uncertainty in the obtained results.

Data acquisition is performed using a commercial stripe projection system. We have replaced the manufacturers software by our own calibration and processing methods, which are based on photogrammetric techniques. This allows us to quantify measurement uncertainty, characterized by an error covariance matrix, and propagate it through all processing steps. Covariance information is also used to improve registration accuracy within pairwise registration and within a new

multi-view registration procedure. The geometric deviation between the sensed surface and the CAD model is computed in the validation step. Statistical tests can then be applied to convert the validation results into a traffic light model where red stands for a significant discrepancy, yellow indicates potential problems and green indicates that the part or a specific feature meets its specification. Therefore, the user can easily judge the results in a transparent manner.

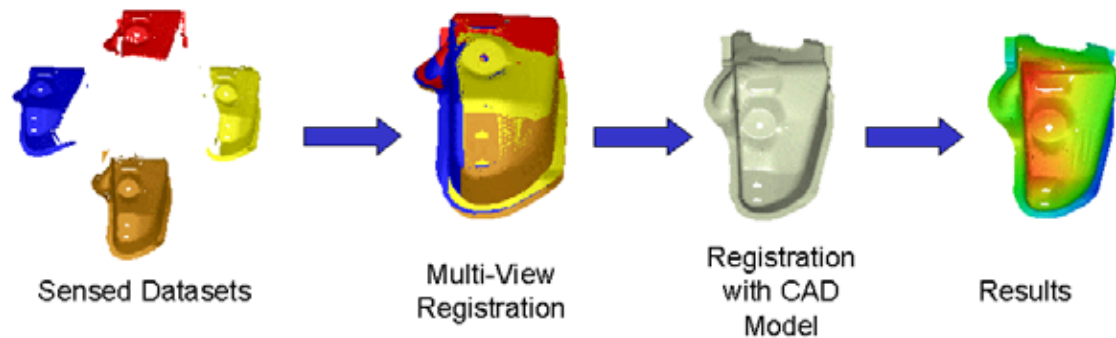

*Multi-View registration process.*

## Photogrammetric Robot Tracking

Goal of this research is the investigation of novel measurement and control procedures for robots. The robot control is to be coupled with a photogrammetric measurement system, which determines the current position and orientation (pose) of the end-effector. Within a control loop, this data is used to correct the position and orientation of the end effector and thereby increase accuracy. For the reason of long-term effects, like wear and tear, the robot must be reprogrammed after a certain amount of time. This causes considerable standstills which are associated with high costs. Linking a photogrammetric measurement system to the robot control software enables automation or avoidance of the reprogramming task.

There are two fundamentally different approaches for measuring the six pose of the robot end effector. Either two or more cameras are fixed in 3-D space, observing target points which are mounted on the (moving) end effector. Alternatively, one or more cameras can be mounted on the end effector itself, observing (fixed) targets in 3-D space. The corresponding photogrammetric techniques are forward intersection and resection, respectively.



(a)

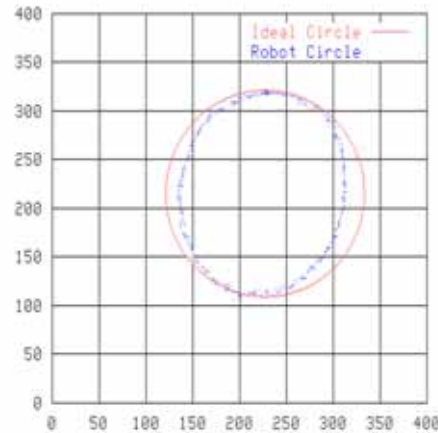

(b)

(a) Camera on the robot observing fixed targets in 3D space. (b) Divergence of the robot path form ideal circle (Scale: 10).

## References 2000

- Ameri, B.: Feature Based Model Verification (FBMV): a new Concept for Validation in Building Reconstruction. In: IAPRS Vol. XXXIII, Part B3/1, pp. 24-35, Amsterdam, 2000.
- Ameri, B., Fritsch D.: Automatic 3D Building Reconstruction Using Plane Roof Structures, Proceed. ASPRS Spring Meeting 2000.
- Anders, K.-H. and Sester M.: Parameter-Free Cluster Detection in Spatial Databases and ist Application to Typification. In: IAPRS Vol. XXXIII, Part B4/1, pp. 75-82, Amsterdam, 2000.
- Böhm, J., Brenner, C.: Curvature based range image classification for object recognition in: 'Intelligent Robots and Computer Vision XIX: Algorithms, Techniques, and Active Vision', SPIE 4197, Boston, 2000.
- Böhm, J., Brenner, C., Gühring, J., Fritsch, D.: Automated Extraction of Features from CAD Models for 3D Object Recognition. In: IAPRS Vol. XXXIII, Part B5, Amsterdam, 2000.
- Brenner, C.: Towards Fully Automatic Generation of City Models. In: IAPRS Vol. XXXIII, Part B3/1, pp. 85-92, Amsterdam, 2000.
- Brenner, C. and Haala, N.: Erfassung von 3D Stadtmodellen. PFG - Photogrammetrie, Fernerkundung, Geoinformation, Heft 2/2000, pp.109 - 118, 2000.
- Cramer, M., Stallmann, D. and Haala, N.: Direct Georeferencing Using GPS/Inertial Exterior Orientations for Photogrammetric Applications. in: IAPRS Vol. XXXIII, Part B3/1 pp. 198-206, Amsterdam, 2000.

- Fritsch, D.: Vom Potential der einfachen Schicht zur Bayes-Schätzung, Laudatio auf Karl-Rudolf Koch, Reden und Aufsätze, Universität Stuttgart, Nr. 62, S. 12 - 20.
- Fritsch, D.: Spending a life for photogrammetry - on the occasion of the 70th birthday of Prof. Dr. mult. Fritz Ackermann, ISPRS Journal of Photogrammetry & Remote Sensing, Vol.55, No.1, pp.3-8, 2000.
- Fritsch, D., Klinec, D., Volz, S.: NEXUS - Positioning and Data Management Concepts for Location Aware Applications. In: Proc. of the 2nd International Symposium on Telegeoprocessing, Nice-Sophia-Antipolis, France, pp. 171-184, 2000.
- Fritsch, D. and Stallmann, D.: Rigorous Photogrammetric Processing of High Resolution Satellite Imagery. In: IAPRS Vol. XXXIII, Part B1, pp. 313-321, Amsterdam, 2000.
- Glemser, M., Klein, U., Fritsch, D., Strunz, G.: Complex Analysis Methods in Hybrid GIS Using Uncertain Data. In: GIS - Geo-Informationssysteme, 2/2000, pp. 34-40, Wichmann Verlag, Heidelberg.
- Glemser, M. and Klein, U.: Hybrid Modelling and Analysis of Uncertain Data. In: IAPRS Vol. XXXIII, Part B4/2, pp. 491-498, Amsterdam, 2000.
- Gühring, J., Brenner, C., Böhm, J., Fritsch, D.: Data processing and calibration of a cross-pattern stripe projector. In: IAPRS Vol. XXXIII, B5, pp. 76 - 83, Amsterdam, 2000.
- Haala, N., Klinec, D. and Brenner, C.: Erfassung, Visualisierung und Interaktion von 3D-Geodaten am Beispiel von NEXUS. Visualisierung raumbezogener Daten: Methoden und Anwendungen, Bd. II. Institut für Informatik, Universität Münster, pp. 171-191, 2000.
- Haala, N., Fritsch, D., Stallmann, D. and Cramer M.: On the performance of digital airborne push-broom cameras for photogrammetric data processing - a case study. In: IAPRS Vol. XXXIII, Part B4/1, pp. 324 - 331, Amsterdam, 2000. Also appeared in GIS, Vol. 13, pp. 29-35.
- Hefele, J. Brenner C.: Robot pose correction using photogrammetric tracking. In: Machine Vision and Three-Dimensional Imaging Systems for Inspection and Metrology, Photonics East, Boston, 2000.
- Hild, H.; Haala, N. and Fritsch, D.: A Strategy for Automatic Image To Map Registration. In: IAPRS Vol. XXXIII, Part B2, pp. 313-321, Amsterdam, 2000.
- Klinec, D., Volz, S.: NEXUS - Positioning and Communication Environment for Spatially Aware Applications. In: IAPRS Vol. XXXIII, pp.324-330. Amsterdam 2000.
- Schürle T., Fritsch D.: Planung und Durchführung eines Benchmarks zur Auswahl eines CAFM-Systems. In: CAD 2000, Berlin, pp. 509 - 524.
- Schürle, T.: CAFM Data Structures: A Review and Examples. In: IAPRS Vol. XXXIII, Part B4/3, pp. 909-916, Amsterdam, 2000.
- Sester M.: Generalization Based on Least Squares Adjustment. In: IAPRS Vol. XXXIII, Part B4/3, pp. 931-938, Amsterdam, 2000.

- Sester, M., Klein, U., Glemser, M. and Walter, V.: GIS-Möglichkeiten, Grenzen und neue Methoden, Beiträge zum internationalen Workshop: GIS-gestützte hydrologische Kartenwerke in Mitteleuropa, Bundesanstalt für Gewässerkunde Mitteilung Nr. 21, 26-36, 2000.
- Volz, S., Sester, M., Fritsch, D., Klinec, D.: Nexus- eine Plattform für ortsabhängige, veteilte Geodatennutzung. In: Albertz, J. (Hrsg.): Publikationen der Deutschen Gesellschaft für Photogrammetrie und Fernerkundung, Band 8, S. 137-150, Berlin, 2000.
- Volz, S., Sester, M.: Distributed Data Management Concepts for Location Aware Applications. Proceedings of the international workshop on emerging technologies for geo-based applications, Ascona, Switzerland, 2000.
- Volz, S., Sester, M., Fritsch, D., Leonhardi, A.: Multi-Scale Data Sets in Distributed Environments. In: IAPRS, Vol..XXXIII, Part B4, Technical IV/I, Amsterdam, 2000.
- Walter, V.: Automatic change detection in GIS databases based on classification of multispectral data. In: IAPRS, Vol. XXXIII, Part B4/3, 1138 - 1145. Amsterdam, 2000.
- Walter, V.: Using New Computer Aided Techniques: Can manual updating of GIS data become obsolete?, GeoInformatics No. 6, Vol. 3, September 2000, 38 - 41, 2000.
- Walter, V. and Fritsch, D.: Automated revision of GIS databases. In: Ki-Joune Li et. al. (Edts): Proceedings of the eight ACM symposium on advances in geographic information systems Washington, 129-134, 2000.

## Diploma Theses

- Mathias Rott: Die Entwicklung einer interaktiven, internetbasierten Datenbankanwendung zur Aktualisierung von ausgewählten Verkehrsdaten.
- Michael Eberle: Intensitätsbasierte Erweiterung des Iterative Closest Point Algorithmus zur Registrierung von 3D-Datensätzen.
- Tilo Bernhardt : Vergleich der Programmpakete MATCH-T und VirtuoZo zur Berechnung Digitaler Höhen- und Geländemodelle.
- Nicolaus Köhler: Genauigkeitsbetrachtung der stereoskopischen Vermessung von Fahrzeugen.
- Sandra Waller: Aufbau eines städtischen Parkrauminformationssystem mit Anbindung an das Internet.
- Thorsten Hoff: Die Erstellung eines eigenständigen, interaktiven - graphischen Windowsprogramms zur automatischen Muster- und Linienerkennung in Rasterbildern.
- Murat Birer: Erstellen einer DLL zum benutzerdefinierten Export von Daten aus Pictran an ArcView.
- Janet Fischer: Untersuchungen zur Multispektralklassifikation mittels Multi-Skalen- und Hierarchischen Ansätzen.

## Study Theses

- Jan-Martin Bofinger: Realisierung von verteilten GIS-Funktionalitäten unter Verwendung der Java Remote Method Invocation.
- Sylvia Scholz: Automatische Generalisierung von Verkehrswegen in Geo-Informationssystemen (GIS).
- Jan-Martin Bofinger: Dichte dreidimensionale Oberflächenerfassung mittels Streifenprojektion unter Verwendung von Standardkomponenten.
- Dietmar Sprenger: Messtool und einfache Orientierungsverfahren zur Auswertung digitaler Bilder.
- Nikolaos Tsoukalas: Vorbereitung und Durchführung bathymetrischer Vermessungen mit dem Forschungsschiff Polarstern im Rahmen eines geophysikalischen Untersuchungsprogramms im zentralen Arktischen Becken.
- Michal Beck: Digitalisierung und Visualisierung eines 3D Gebäudemodells.
- Nicolaus Köhler: Überführung von ATKIS - Daten im Maßstab 1:25.000 in Daten im Maßstab 1:50.000 mittels Objektgeneralisierung in ArcView GIS 3.1 - ein Modellversuch.
- Michael Eberle: Untersuchung zum Räumlichen Rückwärtsschnitt mittels des RANSAC-Algorithmus.
- Christoph Dold: Direkte Georeferenzierung für photogrammetrische Anwendungen.

## Doctoral Theses Supervisor Dieter Fritsch

- Wolfgang Schmid: Berechnung kürzester Wege in Straßennetzen mit Wegeverböten. Diss. ifp
- Michael Kiefner: Einfluss von Bildkompressionsverfahren auf die Qualität der digitalen Punktübertragung. Diss. ifp
- Michael Cramer: Genauigkeitsuntersuchungen zur GPS/INS-Integration in der Aerophotogrammetrie. Diss. ifp
- Claus Brenner: Dreidimensionale Gebäuderekonstruktion aus digitalen Oberflächenmodellen und Grundrissen. Diss. ifp
- Babak Ameri: Automatic recognition and 3D Reconstruction of Buildings from Digital Imagery. Diss. ifp
- Alireza Ardalán: High resolution regional Geoid Computation in the World Geodetic Datum 2000, based upon Collocation of Linearized Observational Functions of the Type GPS, Gravity Potential and Gravity Density. Diss. GI
- Carola Stauch: GIS als entscheidungsunterstützendes Werkzeug in der Verkehrsplanung - am Beispiel von Flächenzerschneidung und Immissionsbelastung. Diss. ILPOE

## Habilitation

Monika Sester: Maßstabsabhängige Darstellung in digitalen räumlichen Datenbeständen

## Activities in National and International Organizations

Dieter Fritsch

Vice President 'Education' of the University of Stuttgart (until Sept. 30, 2000)

President of the University of Stuttgart (from Oct. 1st. 2000)

President of Commission IV of ISPRS (until July 2000)

Editor-in-Chief of the journal 'Geo-Information-Systeme GIS'

Monika Sester

Head of Working Group "Geographic Information Systems" of the German Society for Photogrammetry and Remote Sensing (DGPF)

## Education - Lecture/Practice/Training/Seminar

Adjustment theory and Statistical Inference I,II,III (Fritsch, Gühring)	5/3/0/0
Aerotriangulation and Stereo Plotting (Fritsch, Cramer)	1/1/0/0
Artificial Intelligence (Sester)	2/0/0/0
Cartography (Haala)	1/1/0/0
Civil Law (Schwantag)	2/1/0/0
Close Range Photogrammetry (Brenner, Gühring)	1/1/0/0
Digital Elevation Models (Fritsch, English)	1/1/0/0
Digital Image Processing (Haala)	1/1/0/0
Geodetic Seminar I, II (Fritsch, Grafarend, Keller, Kleusberg, Möhlenbrink)	0/0/0/4
Geographic Information Systems I,II,III (Fritsch, Sester, Walter, Schürle)	5/1/0/0
Geographic Information Systems for Infrastructure Planning (Sester, Ameri)	2/1/0/0
Geographic Information Systems for Environmental Monitoring (Walter, Volz)	2/1/0/0
Geometry and Graphical Representation (Cramer)	1/1/0/0
GIS in Public Administration (Glemser)	1/1/0/0
Introduction to Photogrammetry (Fritsch, Cramer)	1/1/0/0
Image Processing and Pattern Recognition I,II (Haala, Sätter)	4/1/0/0
Image Acquisition and Mono Plotting (Fritsch, Cramer)	2/1/0/0
Practical Training in GIS (Glemser)	0/0/4/0
Practical Training in Digital Image Processing (Haala)	0/0/4/0
Programming in C (Haala, Brenner)	1/1/0/0
Signal Processing for Geodesists (Fritsch, Brenner)	2/1/0/0
Software Development (Fritsch, Grafarend, Keller, Kleusberg, Möhlenbrink)	0/0/4/0
Urban Planning (Schäfer)	2/1/0/0

